

CATALOG

Kathrein Solutions

IoT Portfolio 2022

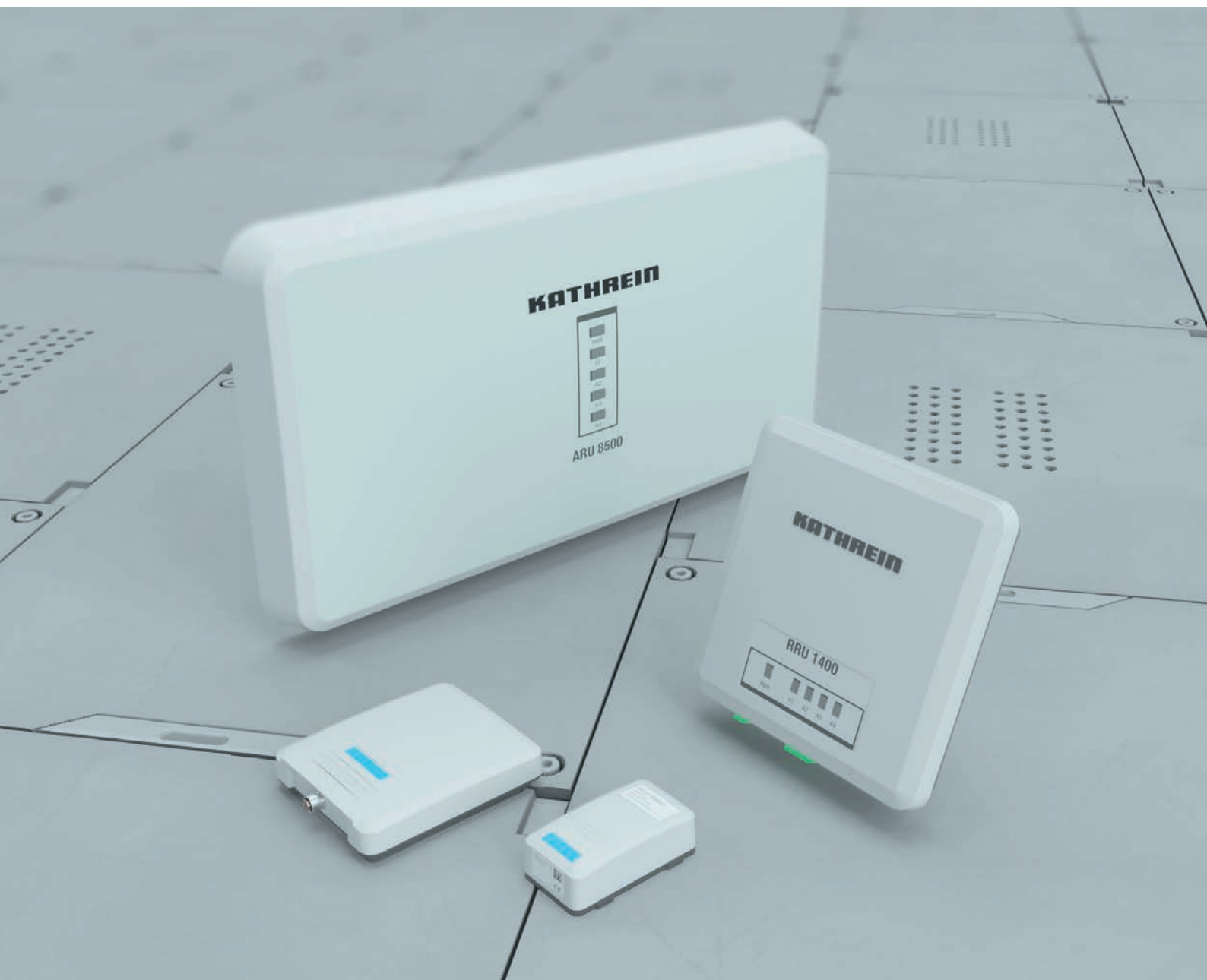

KATHREIN

Enabling Technologies for Digital Transformation

From proof of concept (PoC) through to go-live, Kathrein Solutions supports its partners in implementing turnkey projects in the areas of production and logistics, healthcare, automotive and intelligent transportation systems. With seamless integration of all types of identification technology, such as RFID and RTLS solutions, barcode readers and Wide Area Network technologies – we combine the most

appropriate features and generate interfaces with all types of ERP systems and backends. We and our partners offer RF simulation, application support, software integration and implementation, as well as operation and maintenance. First-class service and customer-focused support add the finishing touch to our portfolio.

> RAIN RFID hardware

Passive UHF (Ultra High Frequency 860-960 MHz) RFID (Radio Frequency Identification) and RAIN RFID are passive identification technologies which allow reading from any distance, from a few centimeters to 20 meters, depending on the application. From individual readings up to thousands of transponders, anything is feasible.

> RAIN RFID software

Kathrein and its partners create solutions for our end customers that are tailored to suit their environment and requirements. This can mean highly complex, filtered event data with backend integration or a simple raw data push solution.

> K-RTLS hardware

Kathrein Solutions' innovative UWB RTLS (Ultra Wide Band Real Time Locating System) is an active localization solution. Using triangulation of our nodes, transponders can be localized with an accuracy of +/- 25 cm in an appropriate environment.

> K-RTLS software

Kathrein offers its partners the option to create optimal solutions for localization of goods, with existing software modules combined to create a tailor-made solution for the end customer.

> Professional services

Kathrein Solutions' hardware and software components enjoy an outstanding reputation all over the world. Together with our partners, we also offer excellent services that complete our overall portfolio. We offer a top-quality portfolio of various services and support that meets the highest standards, allowing us to assist our partners and customers seamlessly throughout the entire lifecycle of their project.

> Special solutions

Our very wide range of services means that we can provide comprehensive support to our partners and customers. Where requirements are specific, even extreme, only a unique innovation will deliver the results that are needed. Kathrein Solutions offers all-encompassing development of special readers, embedded transponders, high-security transponders, windshield labels, headlamp tags, etc.

> Kathrein Solutions relies on partners

Companies that are currently driving forward the necessary digitization of their processes in development, production and logistics are facing increasingly rapid pressure to change. At the same time, the requirements at all levels are becoming more and more complex and comprehensive. Future-proof digitization solutions require an intelligent combination of hardware, software and implementation services. A task that is impossible for just one expert to provide alone.

Kathrein launched the Kathrein Partner Ecosystem on this

basis. The addition of a wide variety of skilled partners to the Kathrein Solutions portfolio creates a highly specialized, skilled and efficient network. Extremely well prepared for complex digitization projects at the customer's premises.

Customers benefit from the network of the best possible specialists and quickly available resources. As part of the Kathrein network, partners in turn benefit from access to the project business and professional support in the form of the Kathrein Partner Program.

> The Partner Program: Optimally supported during all phases



Pre-Sales Consulting

PoC/Pilot

Project-Services

Rollout-Services

Go-Live/Support

The Partner Program was designed for the optimal support of Kathrein Partners and is continuously being further developed. As a partner, we respond to your different needs: as distributors, process consultants, system integrators, logistics specialists or solution partners for industry solutions, you need different support from us as a manufacturer.

> **Partner onboarding and training**

We prepare you well for how you present yourself to the customer. To cover both sales and technical aspects. Free initial training in our Kathrein Training Academy provides you with the necessary tools to win over the customer for the long term and to provide optimal advice. Our Technology Consulting training course supports you with basic, advanced or personalized training – to intensify the partnership according to your needs and your desire. You can find out more about our training courses at Kathrein Training Academy on our website.

> **Marketing and sales services**

Kathrein actively supports you with helpful marketing and sales tools during your acquisition phase. This includes both the mutual lead generation and a well-stocked knowledge base, which you can fall back on at any time. Our webinar and “up-to-date” newsletter series are just a few examples. For your customer presentations, we provide you with the appropriate demonstration equipment and invite you to join us at trade fairs.

Projects that have already been successfully implemented in the form of case studies are your best advertisement. Together with you and with the consent of the customer, we write the success story and publish it in appropriate channels upon agreement.

> **After-sales support**

Together with you as a general contractor, we guarantee the end customer high availability during the entire operating life of the system. The customer turns to your second level support in case of service. As a fall-back option, we are once again available to you as a manufacturer with short response times and our third level support team.

Our repair service also ensures quick replacement of components in the event of a problem. This provides the end customer with the security that resources are always available and that they will be provided with prompt and expert support at any time.

We are happy to advise you and your customers on the best support contract model.

> **Pre-sales consulting**

You only have one chance to make a first impression. Your pitch to the customer needs to be well prepared. We support you in this. We prepare the appointment together with the content, accompany you to the presentation on request, create a first rough project concept and provide you with everything you need for the budget and quotation calculation. You will be able to sense our enthusiasm for the future project even at this early stage.

> **Project support**

Even before the order is placed, we give you and the end customer the assurance that the project has been precisely planned. We are able to simulate the final solution set-up under real conditions in our in-house test center. In doing so, we not only check whether all RFID components work well together, and the way in which they need to be configured, but also take a close look at the relevant processes. Kathrein's consulting experts are at your side during this blueprint phase to minimize the project risk and ensure the success of its implementation.

Of course, Kathrein also supports you during installation and commissioning and the exciting go-live phase.

> **Kathrein + Partner = opportunities**

Kathrein Solutions supports you during the entire sales, consulting, implementation, go-live and after-sales phase.

You can think of the Kathrein Solutions Partner Program as a useful toolbox, from which you can help yourself according to your needs. You decide which tools you want to use and for how long in order to successfully implement your projects.

In the past, the addition of core expertise has resulted in new solutions that our partners have developed. For example, replenishment management of containers, in-house pharmaceutical cold chain management, or a track & trace solution in the cloud. What will you develop?

Kathrein partner ecosystem
The addition of expertise



Manufacturing

Logistics

Healthcare

Transportation



RAIN RFID Hardware

K-RTLS

Software

Laboratory/
Test centre

Customised
developments



Pre-Sales Consulting

PoC/Pilot

Project

Rollout

Go-Live/Support

Kathrein partners benefit from broad market access, first-class products and densely networked service.

> What are the benefits of working with Kathrein?

Digitization projects need to be discovered. Whether through joint lead generation campaigns or your own efforts, the Kathrein Partner Program will enable you to identify and implement projects with your existing and new customers: Be it e-kanban replenishment in the supplier industry, the real-time localization of containers or the tracing of sustainable production paths in the supply chain. The market opportunities are there! And we would like to develop them together with you.

The possible applications in manufacturing, logistics, healthcare and transportation are diverse. Our references in these areas will make customer access easier for you.

> Take advantage of the Kathrein USP:

The Kathrein Solutions USP's can be used as a complete portfolio or as individual components (Build Blocks). The modularity and partner-oriented approach offers maximum flexibility.

- Broad portfolio of RAIN RFID portfolio
- Individual development
- K-RTLS real-time localization
- Software
- Simulation test center
- Professional Services
- Kathrein Training Academy



RAIN RFID Hardware

K-RTLS

Software

Laboratory/
Test centreCustomised
developments

Kathrein supports you in the selection and configuration of suitable products for your customer project as well as during all subsequent project phases. As intense as you wish. From the first customer handshake to final acceptance and the subsequent support – you can rely on Kathrein.

>	Company portrait	2		
>	Partner program	3		
>	RAIN RFID readers	8		
	▪ Reader overview	9		
	▪ RRU 4000 reader series	10		
	▪ RRU 1400 reader series	12		
	▪ ARU 3500 reader series	14		
	▪ ARU 2400 reader series	16		
	▪ ARU 8500 reader series	18		
>	RAIN RFID antennas	20		
	▪ Antenna overview	21		
	▪ Wide-range 3070 antenna	22		
	▪ Wide-range 7070 antenna	23		
	▪ Wide-range 6060 antenna	24		
	▪ SmartShelf antenna	25		
	▪ Mid-range antenna	26		
	▪ Low-range antenna	27		
>	RAIN RFID accessories	28		
	▪ RAIN RFID accessories	29-33		
>	RAIN RFID software portfolio	34		
	▪ RFID software overview	35		
	▪ CrossTalk software suite	36		
	▪ CrossTalk Agent	37		
	▪ CrossTalk Server	38		
	▪ CrossTalk Mobile	39		
	▪ Kathrein ReaderStart software	40		
	▪ Kathrein reader application software	40		
>	K-RTLS hardware	42		
	▪ K-RTLS overview	43		
	▪ K-RTLS transponder	44		
	▪ K-RTLS node	46		
	▪ K-RTLS accessories	47		
>	K-RTLS software	48		
	▪ K-RTLS software overview	49		
	▪ CrossTalk software suite	50		
	▪ CrossTalk Agent	51		
	▪ CrossTalk Server	51		
	▪ RTLS infrastructure application	52		
	▪ RTLS Start	53		
>	Professional services	54		
	▪ Professional services overview	55		
	▪ Consulting	56		
	▪ Project management	58		
	▪ Training	60		
	▪ Support	62		
>	Individual development & special solutions	64		
	▪ R&D services	65		
>	Cooperation	66		
>	Pictures	67		



RAIN RFID readers

Kathrein Solutions, passive UHF (Ultra High Frequency 860 – 960 MHz) RFID (Radio Frequency Identification) readers, which meet ISO 18000-6C, impress with their first-class reading performance, flexibility, powerful Linux operating systems and IP protection classes suitable for a wide range of applications.

> Reader overview

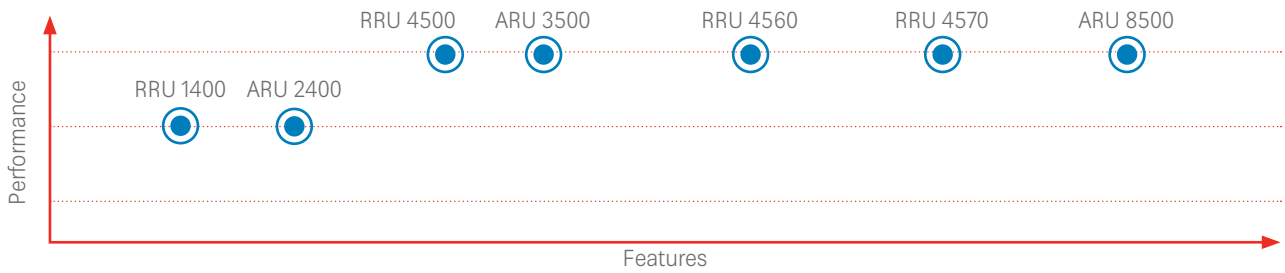

Reader	RRU 1400			RRU 4500				RRU 4560		RRU 4570		ARU 2400		ARU 3500		ARU 8500	
Order-No. Country	52010551	52010552	52010585	52010288	52010296	52010454	52010536	52010289	52010297	52010290	52010298	52010348	52010349	52010537	52010292	52010300	52010340
Australia		✓			✓				✓		✓		✓			✓	
Brazil		✓			✓				✓		✓		✓			✓	
Canada		✓			✓				✓		✓		✓			✓	
China						✓											
EU 865 - 868 MHz	✓			✓				✓		✓		✓		✓			✓
EU 915 - 921 MHz	✓				✓			✓		✓		✓		✓		✓	
Guatemala 902 - 906 MHz		✓			✓				✓		✓		✓			✓	
Guatemala 918 - 923 MHz		✓			✓				✓		✓		✓			✓	
India ¹⁾ 865 - 867 MHz	✓			✓				✓		✓		✓		✓			✓
Indonesia		✓			✓				✓		✓		✓			✓	
Japan		✓			✓				✓		✓		✓			✓	
Mexico		✓			✓				✓		✓		✓			✓	
Morocco	✓			✓				✓		✓		✓		✓			✓
Peru		✓			✓				✓		✓		✓			✓	
Russia ²⁾ 866-868 MHz	✓			✓				✓		✓		✓		✓			✓
Saudi Arabia	✓			✓				✓		✓		✓		✓			✓
Singapore			✓		✓		✓		✓		✓		✓	✓		✓	
South Africa 865 - 868 MHz	✓			✓				✓		✓		✓		✓			
South Africa 915 - 919 MHz		✓			✓				✓		✓		✓			✓	
South Korea		✓			✓				✓		✓		✓			✓	
Thailand		✓			✓				✓		✓		✓			✓	
Turkey ²⁾	✓			✓				✓		✓		✓		✓			✓
USA		✓			✓				✓		✓		✓			✓	
Vietnam		✓			✓				✓		✓		✓			✓	

✓ Country profile and certification in place.

✓ Country profile in place, certification pending.

1) Import via local dealer.

2) License from local company required.

> RRU 4000 reader series

- 33 dBm/2 W conducted power
- Up to 36 dBm ERP/4 W ERP
- Robust design
- Protection class IP67
- Dual-core Linux PC
- PoE+
- ©KRAI
- 2G/3G/4G, WIFI, BLE optional



Name	RRU 4500	RRU 4560	RRU 4570
Order number of ETSI version	52010288	52010289	52010290
Order number of FCC version*	52010296	52010297	52010298
Integrated industrial PC with dual core CPU	✓	✓	✓
Number of Ethernet connections	2	2	2
GPIO	✓	✓	✓
©KRAI	✓	✓	✓
PoE+	✓	✓	✓
LED display	✓	✓	✓
WLAN		✓	
Bluetooth		✓	
2G/3G/4G			✓

* Suitable for application in the ETSI upper band range.

Accessories

Order number	Description	Order number	Description
52010358	10 m RRU/ARU DC power cable	52010364	RRU/ARU AC/DC power supply unit 24 V/90 W
52010359	3 m RRU/ARU DC power cable	52010365	RRU/ARU AC/DC power supply unit 24 V/72 W DIN rail
52010360	10 m RRU/ARU Ethernet cable M12/RJ45	52010366	RRU/ARU AC/DC power supply unit 24 V/90 W DIN rail
52010361	3 m RRU/ARU Ethernet cable M12/RJ45	52010369	PoE+ Ethernet switch, 4 connections
52010362	10 m RRU/ARU GPIO cable M12	52010370	PoE+ injector 30 W, 100 Mbit for RRU, ARU
52010363	3 m RRU/ARU GPIO cable M12	52010351	Outdoor wall bracket
52010373	10 m RRU/ARU Ethernet connection cable	52010261	Indoor wall bracket
		52010367	Vandalism protection for RRU, ARU
		52010376	Protective caps for RRU 4xxx, ARU 3xxx

> RRU 4000 reader overview

RFID UHF reader overview	ETSI version	FCC version
	RRU 45xx	RRU 45xx
Frequency range [MHz]	865-868	902-928 915-921 (ETSI upper band)
Max. TX power, conducted [dBm]	+33	+30 (+33 with extended cable length)
Protocol	EPC Class1 Gen2/ISO 18000-6C	
Number of antenna connections [R-TNC]	4	
Operating system reader	Linux	
Basic computer module	✓	✓
Integrated industrial PC	dual core @ 800 MHz/8 GB/Linux OS	dual core @ 800 MHz/8 GB/Linux OS
©KRAI	✓	✓
Interfaces		
Number of Ethernet connections	2	2
WLAN	RRU 4560	RRU 4560
Bluetooth	RRU 4560	RRU 4560
2G/3G/4G	RRU 4570	RRU 4570
PoE+	PoE+ according to 802.3at (10–57)	
GPIO	4 inputs/4 outputs	
LED display, freely programmable		
Basic LEDs	4	
High-end LEDs	8	
Mechanical properties		
Operating temperature range [°C]	-20 to +55	
Storage temperature range [°C]	-40 to +85	
Dimensions (L x W x H) [mm]	300 x 300 x 71	
Protection class	IP67*	
Standards	EN302208-2 V2.1.1, EN301489-3, EN50364, EN62368-1, EN60529, EPC Gen2 V2, UCODE DNA	
		FCC Part15, UL, IC,

* If all connections are made with a Kathrein cable or have Kathrein protective caps.



> RRU 1400 reader series

- 30 dBm/1 W conducted power
- Up to 36 dBm ERP/4 W ERP
- FAKRA antenna connections
- @KRAI
- IP40
- Small form factor
- Basic computer module



Name	RRU 1400
Order number of ETSI version*	52010551
Order number of FCC version	52010552
Basic computer module	✓
Number of Ethernet connections	1
GPIO	✓
LED display	✓
©KRAI	✓
PoE+	✓

* Suitable for application in the ETSI upper band range.

Accessories

Order number	Description	Order number	Description
52010451	1 m RFID antenna cable, SMA-FAKRA	52010474	R-RPA 24VDC-18W, AC/DC power supply unit
52010452	3 m RFID antenna cable, SMA-FAKRA	52010485	0.5 m RFID antenna cable, FAKRA-FAKRA
52010453	5 m RFID antenna cable, SMA-FAKRA	52010486	1 m RFID antenna cable, FAKRA-FAKRA
52010461	1 m RFID antenna cable, TNC-FAKRA	52010487	3 m RFID antenna cable, FAKRA-FAKRA
52010462	3 m RFID antenna cable, TNC-FAKRA	52010488	5 m RFID antenna cable, FAKRA-FAKRA
52010463	5 m RFID antenna cable, TNC-FAKRA	52010261	Wall mount Kit indoor



> RRU 1400 reader overview

RFID UHF reader overview	ETSI version	FCC version
	RRU 1400	RRU 1400
Frequency range [MHz]	865-868	902-928
Max. TX power, conducted [dBm]	+30	
Number of FAKRA antenna connections	4	
Operating system reader	Linux	
Basic computer module	ARMv7-A based processor with 600 MHz	
©KRAI	✓	
Interface		
Number of Ethernet connections	1	
GPIO	✓	
PoE+	PoE+ according to 802.3at (10-57)	
LED display, freely programmable		
Basic LEDs	4	
Mechanical properties		
Operating temperature range [°C]	-20 to +55	
Storage temperature range [°C]	-40 to +85	
Dimensions (L x W x H) [mm]	167 x 167 x 40	
Protection class	IP40	
Standards	EN302208-2 V2.1.1, EN301489-3, EN50364, EN62368-1, EN60529, EPC Gen2 V2, UCODE DNA	
	FCC Part15, UL, IC	

> ARU 3500 reader series

- 33 dBm/2 W conducted power
- Up to 36 dBm ERP/4 W ERP*
- Integrated 65° antenna
- Robust design
- Protection class IP67
- Dual core Linux PC
- PoE+



Name	ARU 3500
Order number of ETSI version	52010292
Order number of FCC version**	52010300
Integrated industrial PC with dual core CPU	✓
Number of Ethernet connections	2
GPIO	✓
LED display	✓
PoE+	✓

* With external antennas. ** Suitable for application in the ETSI upper band range.

Accessories

Order number	Description	Order number	Description
52010358	10 m RRU/ARU DC power cable	52010364	RRU/ARU AC/DC power supply unit 24 V/90 W
52010359	3 m RRU/ARU DC power cable	52010365	RRU/ARU AC/DC power supply unit 24 V/72 W DIN rail
52010360	10 m RRU/ARU Ethernet cable M12/RJ45	52010366	RRU/ARU AC/DC power supply unit 24 V/90 W DIN rail
52010361	3 m RRU/ARU Ethernet cable M12/RJ45	52010369	PoE+ Ethernet switch, 4-port
52010362	10 m RRU/ARU GPIO cable M12	52010370	PoE+ injector 30 W, 100 Mbit for RRU, ARU
52010363	3 m RRU/ARU GPIO cable M12	52010351	Outdoor wall bracket
52010373	10 m RRU/ARU Ethernet connection cable	52010261	Indoor wall bracket
		52010367	Vandalism protection for RRU, ARU
		52010376	Protective caps for RRU 4xxx, ARU 3xxx

> ARU 3500 reader overview

RFID UHF reader overview	ETSI version	FCC version
	ARU 3500	ARU 3500
Frequency range [MHz]	865-868	902-928 915-921 (ETSI upper band)
Max. TX power, conducted [dBm]	+33	+30 (+33 with extended cable length)
Max. TX power radiated [dBm] int. antenna	+33 ERP	+36 EIRP
Protocol	EPC Class1 Gen2/ISO 18000-6C	
Number of antenna connections [R-TNC]	3	
Operating system reader	Linux	
Integrated industrial PC	dual core @ 800 MHz/8 GB/Linux OS	
Interfaces		
Number of Ethernet connections	2	
PoE+	PoE+ according to 802.3at (10-57)	
GPIO	4 inputs/4 outputs	
Integration of the antenna		
Half-power beam width [°]	65°	
Antenna gain [dBiC]	8.5	
LED display, freely programmable		
Basic LEDs	4	
High-end LEDs	8	
Mechanical properties		
Operating temperature range [°C]	-20 to +55	
Storage temperature range [°C]	-40 to +85	
Dimensions (L x W x H) [mm]	300 x 300 x 71	
Protection class	IP67*	
Standards	EN302208-2 V2.1.1, EN301489-3, EN50364, EN62368-1, EN60529, EPC Gen2 V2, UCODE DNA	
	FCC Part15, UL, IC	

* If all connections are made with a Kathrein cable or have Kathrein protective caps.

> ARU 2400 reader series

- 30 dBm/2 W conducted power
- Up to 36 dBm ERP/4 W ERP*
- FAKRA antenna connections
- IP40
- PoE+
- @KRAI
- Basic computer module



Name	ARU 2400
Order number of ETSI version	52010348
Order number of FCC version**	52010349
Basic computer module	✓
Number of Ethernet connections	1
GPIO	✓
LED display	✓
PoE	✓
@KRAI	✓

* With external antennas. ** Suitable for application in the ETSI upper band range.

Accessories

Order number	Description
52010451	1 m RFID antenna cable, SMA-FAKRA
52010452	3 m RFID antenna cable, SMA-FAKRA
52010453	5 m RFID antenna cable, SMA-FAKRA
52010461	1 m RFID antenna cable, TNC-FAKRA
52010462	3 m RFID antenna cable, TNC-FAKRA
52010463	5 m RFID antenna cable, TNC-FAKRA
52010474	R-RPA 24VDC-18W, AC/DC power supply unit
52010261	Wall mount Kit indoor

Order number	Description
52010479	MK-SHM-4P fitting kit for shelf assembly
52010485	0.5 m RFID antenna cable, FAKRA-FAKRA
52010486	1 m RFID antenna cable, FAKRA-FAKRA
52010487	3 m RFID antenna cable, FAKRA-FAKRA
52010488	5 m RFID antenna cable, FAKRA-FAKRA

> ARU 2400 reader overview

RFID UHF reader overview	ETSI version	FCC version
	ARU 2400	ARU 2400
Frequency range [MHz]	865-868	902-928 915-921 (ETSI upper band)
Max. TX power conducted [dBm]	+27	
Max. TX power radiated [dBm] int. antenna	+30	
Protocol	EPC Class1 Gen2V2/ISO 18000-6C	
Number of antenna connections	3, Fakra connector, Z-coded	
Operating system reader	Linux	
Basic computer module	ARMv7-A based processor with 600 MHz	
@KRAI	✓	
Integration of the antenna		
Half-power beam width [°]	60	
Gain, circular [dBiC]	typ. 5.5	
Interface		
Ethernet	1	
PoE	PoE Class 0 according to 802.3at (10-57)	
GPIO	2 inputs, 2 outputs	
LED display, freely programmable	4 basic LEDs	
Mechanical properties		
Operating temperature range [°C]	-20 to +55	
Storage temperature range [°C]	-40 to +85	
Dimensions (L x W x H) [mm]	300 x 300 x 49	
Protection class	IP40	
Standards	EN302208-2 V2.1.1, EN301489-3, EN50364, EN62368-1, EN60529, EPC Gen2 V2, UCODE DNA	
	FCC Part15, UL, IC	

> ARU 8500 reader series

- 33 dBm/2 W conducted power
- Direction recognition by integrated switch-beam antenna
- Up to 36 dBm ERP/4 W ERP*
- IP40
- Dual core Linux PC
- 3 other external antenna connectors



Name	ARU 8500
Order number of ETSI version	52010340
Order number of FCC version**	52010341
Integrated industrial PC with dual core CPU	✓
Number of Ethernet connections	2
GPIO	✓
LED display	✓
PoE+	✓
Antenna system	Phased array antennas with 3 reading zones

* For external antennas. ** Suitable for application in the ETSI upper band range.

Accessories

Order number	Description	Order number	Description
52010358	10 m RRU/ARU DC power cable	52010364	RRU/ARU AC/DC power supply unit 24 V/90 W
52010359	3 m RRU/ARU DC power cable	52010365	RRU/ARU AC/DC power supply unit 24 V/72 W DIN rail
52010360	10 m RRU/ARU Ethernet cable M12/RJ45	52010366	RRU/ARU AC/DC power supply unit 24 V/90 W DIN rail
52010361	3 m RRU/ARU Ethernet cable M12/RJ45	52010369	PoE+ Ethernet switch, 4-port
52010362	10 m RRU/ARU GPIO cable M12	52010370	PoE+ injector 30 W, 100 Mbit for RRU, ARU
52010363	3 m RRU/ARU GPIO cable M12	52010351	Outdoor wall bracket
52010373	10 m RRU/ARU Ethernet bridge cable	52010261	Indoor wall bracket
		52010367	Vandalism protection for RRU, ARU, WRA 70
		52010376	Protective caps for RRU, ARU

> ARU 8500 reader overview

Frost & Sullivan awarded Kathreins ARU8500 with the 2020 Best Practices Award for the “European RFID Reader in Manufacturing and Logistics New Products Innovation”.

With its 30° antenna and dynamic reading zones, the ARU8500 reader facilitates direction detection of

moving goods. 3 additional antenna connectors mean that it offers the highest precision even in industrial environments. It is therefore the perfect solution for incoming and outgoing goods, anti-theft monitoring in retail, asset tracking and many other logistics applications.

RFID UHF reader overview	ETSI version	FCC version
	ARU 8500	ARU 8500
Frequency range [MHz]	865-868	902-928 915-921 (ETSI upper band)
Max. TX power radiated [dBm]	+33	+30 (+33 with extended cable length)
Max. TX power radiated [dBm]	+33 ERP	+36 EIRP
Protocol	EPC Class1 Gen2/ISO 18000-6C	
Number of antenna connections	6 (3 = left/middle/right + 3 ext. R-TNC)	
Operating system reader	Linux	
Basic computer module	✓	
Integrated industrial PC	dual core @ 800 MHz/8 GB/Linux OS	
Integration of the antenna		
Half-power beam width [°]	30 vertical/80 horizontal	
Gain left / middle / right [dBIC]	7.0/8.0/7.0	
Deflection of the detection areas	+35/0/-35	
Polarization	circular	
Interface		
Ethernet	2	
PoE+	PoE+ according to 802.3at (10-57)	
GPIO	4 inputs/4 outputs	
LED display, freely programmable	4 basic LEDs	
Mechanical properties		
Operating temperature range [°C]	-20 to +55	
Storage temperature range [°C]	-40 to +85	
Dimensions (L x W x H) [mm]	656 x 362 x 112	
Protection class	IP40	
Standards	EN302208-2 V2.1.1, EN301489-3, EN50364, EN62368-1, EN60529, EPC Gen2 V2, UCODE DNA	
	FCC Part15, UL, IC	



RAIN RFID antennas

Kathrein Solutions, passive UHF-RFID antennas impress with their high performance even under the harshest conditions. Suitable for a wide range of applications thanks to read ranges from a few centimeters up to 20 meters, our portfolio always has the right component. Special properties such as ©KRAI (Kathrein RFID Antenna Interface) also facilitate various intelligent functions, such as polarization switching and antenna cascading.

> Antenna overview

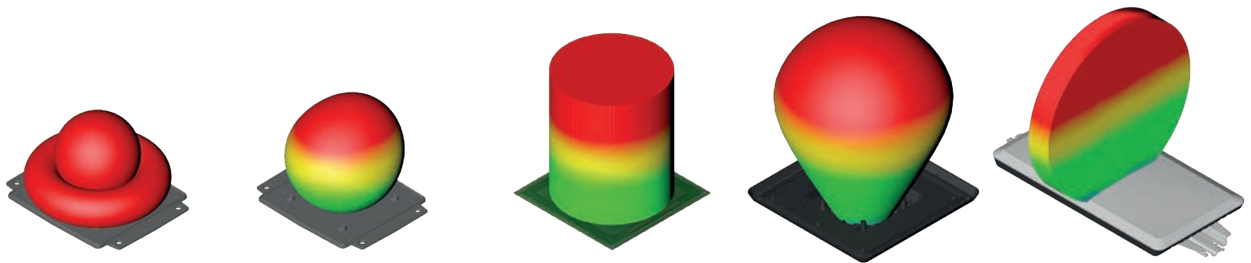
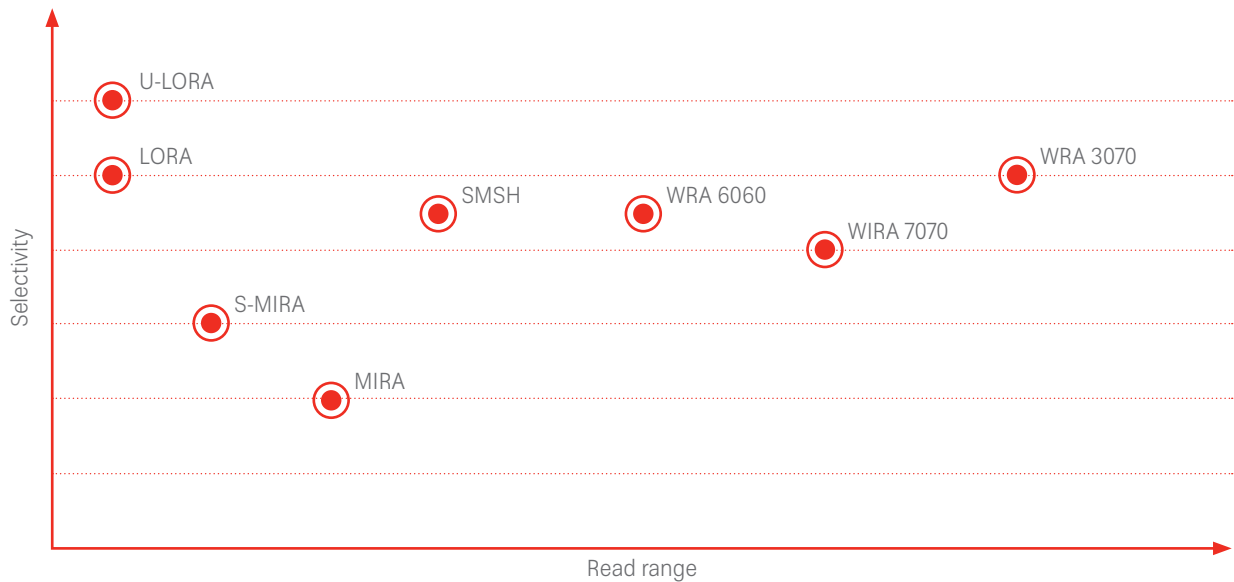

U-LORA / LORA	S-MIRA / MIRA	SMSH HG / WRA 6060	WRA 7070 / WRA 7070 KRAI	WRA 3070
Opening angle				
-	100°/100°	60°/60°	65°/65°	30°/65°
Reading range				
< 0.1 m	0 - 2 m	0 - 5 m	0 - 10 m	> 10 m
Applications				
Access control	Tracking goods	Tracking goods	Gate applications	Vehicle identification
Automation	Material transport	Material transport	Production lines	Loading gates
Medical practices	Point of sale (tills)	Point of sale (tills)	Parking garage barriers	Border control
	Kanban shelves	Kanban shelves	Train identification	Container identification
	Smart shelves	Smart shelves	Tracking goods	Retail tunnel
	Conveyor belts	Conveyor belts	Security gates	Airport luggage

> Wide-range 3070 antenna overview

- new compact design
- Read range up to 20 m
- Excellent axial ratio
- Mounting kit for pole mount or gantry mount included
- Ideal for portal applications and vehicle identification



Order number	ETSI version	FCC version
	52010583	52010584
Name	WRA 3070 antenna unit ETSI	WRA 3070 antenna unit FCC
Frequency range [MHz]	865-868	902-928
Half-power beam width [°]	30/65	
Polarization	circular	
Antenna gain [dBIC]	typ. 12	typ. 11,5
VSWR	< 1.2:1	
Connector	TNC	
Operating temperature range [°C]	-40 to +70	
Storage temperature range [°C]	-40 to +85	
Protection class	IP67*	
Dimensions (L x W x H) [mm]	610 x 320 x 95	

* When connected with the Kathrein antenna cable.

Accessories

Order number	Description
52010174	3 m low-loss 240 antenna cable TNC/TNCR
52010175	6 m low-loss 240 antenna cable TNC/TNCR
52010176	10 m low-loss 240 antenna cable TNC/TNCR
52010177	15 m low-loss 240 antenna cable TNC/TNCR
52010250	15 m low-loss antenna cable N/TNCR
52010598	R-AA TNC-TNC adaptor, right angle plug
52010351	Outdoor wall bracket

> Wide-range 7070 antenna overview

- Compact design
- Protection class IP67
- Read range up to 12 m
- Homogeneous reading field with symmetrical pattern
- ©KRAI interface for switching polarization (LHCP, RHCP, lin. hor., lin. ver.)
- Ideal for logistics applications and for recording vehicles



Order number	ETSI version		FCC version	
	52010333	52010335	52010334	52010336
Name	WRA 7070 antenna unit	WRA 7070 ©KRAI antenna unit	WRA 7070 antenna unit	WRA 7070 ©KRAI antenna unit
Frequency range [MHz]	865-868		902-928	
©KRAI	–	✓	–	✓
LED display, freely programmable	–	4 high-end LEDs	–	4 high-end LEDs
Half-power beam width [°]	65/65			
Circular polarization	RHCP**	LHCP/RHCP*	RHCP**	LHCP/RHCP*
Antenna gain circular [dBiC]	typ. 8.5 (at 866 MHz)	typ. 6.5	typ. 8.5 (at 915 MHz)	typ. 6.5
Axial ratio	typ. 1	typ. 2	typ. 1	typ. 2
Linear polarization	–	horizontal/vertical	–	horizontal/vertical
Antenna gain linear [dBi]	–	7.0	–	7.0
VSWR	typ. 1.2:1	typ. 1.4:1	typ. 1.2:1	typ. 1.8:1
Connection	TNC female			
Operating temperature range [°C]	-40 to +70			
Storage temperature range [°C]	-40 to +85			
Protection class	IP67***			
Dimensions (L x W x H) [mm]	300 x 300 x 49			

* Left-hand/right-hand circular polarization. ** Right-hand circular polarization. *** When connected with the Kathrein antenna cable.

Accessories

Order number	Description
52010174	3 m low-loss 240 antenna cable
52010175	6 m low-loss 240 antenna cable
52010176	10 m low-loss 240 antenna cable TNC/TNCR
52010177	15 m low-loss 240 antenna cable TNC/TNCR

Order number	Description
52010261	Indoor wall bracket
52010351	Outdoor wall bracket
52010479	Shelf fitting kit for ARU 2400 Reader, WRA 6060, WRA 7070

> Wide-range 6060 antenna overview

- Compact design
- Protection class IP67
- Read range up to 5 m
- Homogeneous, selective reading field with symmetrical pattern
- Very high front/back ratio
- For applications in the radiated near field and for identification of static transponders



Order number	ETSI version	FCC version
	52010423	52010424
Name	WRA 6060 antenna unit	WRA 6060 antenna unit
Frequency range [MHz]	865-868	902-928
Half-power beam width [°]	60/60	
Polarization	circular, RHCP*	
Antenna gain [dBiC]	typ. 5.5 (at 866 MHz)	typ. 5.5 (at 915 MHz)
Axial ratio	typ. 1	
VSWR	typ. 1.2:1	
Connection	TNC female	
Operating temperature range [°C]	-40 to +70	
Storage temperature range [°C]	-40 to +85	
Protection class	IP67**	
Dimensions (L x W x H) [mm]	300 x 300 x 49	

* Right-hand circular polarization. ** When connected with the Kathrein antenna cable.

Accessories

Order number	Description
52010174	3 m low-loss 240 antenna cable TNC/TNCR
52010175	6 m low-loss 240 antenna cable TNC/TNCR
52010176	10 m low-loss 240 antenna cable TNC/TNCR
52010177	15 m low-loss 240 antenna cable TNC/TNCR
52010351	Outdoor wall bracket
52010261	Indoor wall bracket
52010479	Shelf fitting kit for ARU 2400 Reader, WRA 6060, WRA 7070

> SmartShelf antenna overview

- Super-slim design
- Read range up to 3 m
- Homogeneous, selective reading field with symmetrical pattern
- Robust and vibration-resistant
- Cascadable with up to 32 antennas using ©KRAI
- Suitable for e-KanBan and logistics applications



Order number	ETSI version		FCC version	
	52010523	52010524	52010525	52010526
Name	SMSH antenna	SMSH ©KRAI antenna	SMSH antenna	SMSH ©KRAI antenna
Frequency range [MHz]	865-868		902-928	
©KRAI	–	cascading	–	cascading
Protective cover	✓			
Reading range [m]	0-3			
Polarization	circular, RHCP*			
Antenna gain [dBiC]	typ. 4.5		typ. 5	
Axial ratio [dB]	typ. 2			
VSWR	typ. 1.3:1			
Connection	FAKRA			
Operating temperature range [°C]	-20 to +55			
Storage temperature range [°C]	-40 to +85			
Protection class	Indoor			
Dimensions (L x W x H) [mm]	340 x 330 x 20			* Right-hand circular polarization.

Accessories

Order number	Description
52010485	0.5 m RFID antenna cable, FAKRA-FAKRA
52010486	1 m RFID antenna cable, FAKRA-FAKRA
52010487	3 m RFID antenna cable, FAKRA-FAKRA
52010488	5 m RFID antenna cable, FAKRA-FAKRA
52010527	1 m RFID antenna cable, FAKRA-TNC-R
52010528	3 m RFID antenna cable, FAKRA-TNC-R
52010529	5 m RFID antenna cable, FAKRA-TNC-R

Order number	Description
52010451	1 m RFID antenna cable, SMA-FAKRA
52010452	3 m RFID antenna cable, SMA-FAKRA
52010453	5 m RFID antenna cable, SMA-FAKRA
52010398	Backplane

> Mid-range antenna overview

- Compact, slim design
- Protection class IP67
- Read range up to 2 m
- Suitable for group and individual readings
- Ideal for applications in the industrial environment



Order number	ETSI version	FCC version	Global version
	52010082	52010083	52010172
Name	MIRA-100-circular-ETSI	MIRA-100-circular-FCC	S-MIRA-100-circular-ETSI-FCC
Frequency range [MHz]	865-868	902-928	865-928
Half-power beam width [°]	100		
Reading range [m]	typ. 0.2-2		typ. 0.1-1
Polarization	circular, LHCP*		circular, RHCP***
Antenna gain [dBiC]	2.5 (@ 866 MHz)	2.5 (@ 915 MHz)	-12 (@ 866 MHz) -10 (@ 915 MHz)
Axial ratio [dB]	typ. 1.5		typ. 2.0
VSWR	typ. 1.3:1		typ. 1.4:1
Connection	TNC female		
Operating temperature range [°C]	-20 to +55		
Storage temperature range [°C]	-40 to +85		
Protection class	IP67**		
Dimensions (L x W x H) [mm]	156 x 143.8 x 36		
Dimensions (L x W x H) [mm]	79.5 x 90 x 31		

* Left-hand circular polarization. ** When connected with the Kathrein antenna cable. *** Right-hand circular polarization.

Accessories

Order number	Description
52010174	3 m low-loss 240 antenna cable TNC/TNCR
52010175	6 m low-loss 240 antenna cable TNC/TNCR
52010176	10 m low-loss 240 antenna cable TNC/TNCR
52010177	15 m low-loss 240 antenna cable TNC/TNCR
52010351	Outdoor wall bracket

> Low-range antenna overview

- Extremely high selectivity
- Reading range 20 cm
- Minimal form factor
- Protection class IP67
- Ideal for near-field applications
- Ideal for applications in the industrial environment



Order number	ETSI version	FCC version	Global version
	52010084	52010085	52010092
Name	LORA-ETSI	LORA-FCC	U-LORA-ETSI-FCC
Frequency range [MHz]	865-868	902-928	865-928
Range of near-field tags [cm]	typ. 7 @ NF-Tags		typ. 3 @ NF-Tags
Selectivity of near-field tags [cm]	typ. 5 @ NF-Tags		typ. 3 @ NF-Tags
Range of far-field tags [cm]	–	–	typ. 8 @ FF-Tags
Selectivity of far-field tags [cm]	–	–	typ. 10 @ FF-Tags
EIFF [dB]**	20		15
Antenna gain [dBIC]	-15		-30
VSWR	< 1.3:1	< 1.8:1	< 1.2:1
Connection	TNC female		
Operating temperature range [°C]	-20 to +55		
Storage temperature range [°C]	-40 to +85		
Protection class	IP67*		
Dimensions (L x W x H) [mm]	79.5 x 90 x 31		

* When connected with the Kathrein antenna cable. ** EIFF = Effective Isotropic Field Factor.

Accessories

Order number	Description
52010174	3 m low-loss 240 antenna cable TNC/TNCR
52010175	6 m low-loss 240 antenna cable TNC/TNCR
52010176	10 m low-loss 240 antenna cable TNC/TNCR
52010177	15 m low-loss 240 antenna cable TNC/TNCR



RAIN RFID accessories

Power supply, data and I/O connection and assembly accessories for Kathrein Solutions RFID readers and antennas.

> Power Supply

Order number	Name	Description
For RRU 4000, RRU 1400, ARU 3000, ARU 8500, ARU 2400		
52010365	R-RPA 24VDC-72 W	RRU/ARU AC/DC power supply unit 24 V/72 W
52010366	R-RPA 24VDC-90 W	RRU/ARU AC/DC power supply unit 24 V/90 W
52020369	R-ETH-SW-100	PoE+ Ethernet switch, 4-port
52010370	R-POE-INJ-30	PoE+ injector, 30 W, 100 Mbit for RRU and ARU
For RRU 4000, ARU 3000, ARU 8500		
52010364	R-RPA3 24VDC-90 W	RRU/ARU AC/DC POWER SUPPLY UNIT 24 V/90 W
For ARU 2400 and RRU 1400		
52010474	R-PRA 24DC-18W	AC/DC power supply unit 24 V/18 W, AC 110–230 V, mains plug device, replaceable AC plug



52010365



52010366



52010369



52010370



52010364



52010474

> Reader connection cable for RRU 4000, ARU 3000, ARU 8500

Order number	Name	Length	Description
52010358	R-CC3-10-DC	10 m	RRU/ARU DC power cable
52010359	R-CC3-03-DC	3 m	RRU/ARU DC power cable
52010360	R-CC3 10 ETH	10 m	RRU/ARU Ethernet cable M12/RJ45
52010361	R-CC3-03-ETH	3 m	RRU/ARU Ethernet cable M12/RJ45
52010362	R-CC3 10 GPIO	10 m	RRU/ARU GPIO cable M12
52010363	R-CC3-03-GPIO	3 m	RRU/ARU GPIO cable M12
52010373	R-BC3-10-ETH	10 m	RRU/ARU Ethernet bridge cable
52010431	R-AC3 GPIO	0.5 m	RRU/ARU adapter cable GPIO, IP65, M12 male 12-pole, A-coded, 2x M12 female 8-pole, A-coded
52010432	R-AC3 ETH	0.5 m	RRU/ARU adapter cable Ethernet, IP65, M12 female 4-pole, D-coded, M12 male 8-pole, X-coded
52010376	PCS-G3-IP67		Protective cap set for RRU 4000, ARU 3000, IP67



52010358/359



52010360/361



52010362/363



52010373



52010431



52010376

> Antenna cables

Order number	Name	Description
For RRU 4000, ARU 8500, ARU 3000		
52010174	R-AC 3 TNC-TNCR	LL 240 flex, L = 3 m, IP65 robust design
52010175	R-AC 6 TNC-TNCR	LL 240 flex, L = 6 m, IP65 robust design
52010176	R-AC 10 TNC-TNCR	LL 240 flex, L = 10 m, IP65 robust design
52010177	R-AC 15 TNC-TNCR	LL 240 flex, L = 15 m, IP65 robust design
52010598	R-AA TNC-TNC	TNV socket (f) to TNC plug (m), right angle plug
52010527	R-AC 1 FAKRA-TNCR	RFID-antenna-cable, L=1 m, IP40, FAKRA Z-coded to TNCR
52010528	R-AC 3 FAKRA-TNCR	RFID-antenna-cable, L=3 m, IP40, FAKRA Z-coded to TNCR
52010529	R-AC 5 FAKRA-TNCR	RFID-antenna-cable, L=5 m, IP40, FAKRA Z-coded to TNCR
For ARU 2400 and RRU 1400		
52010485	R-AC 0.5 FAKRA-FAKRA	RFID-antenna-cable, L=0.5 m, IP40, FAKRA Z-coded to FAKRA Z-coded
52010486	R-AC 1 FAKRA-FAKRA	RFID-antenna-cable, L=1 m, IP40, FAKRA Z-coded to FAKRA Z-coded
52010487	R-AC 3 FAKRA-FAKRA	RFID-antenna-cable, L=3 m, IP40, FAKRA Z-coded to FAKRA Z-coded
52010488	R-AC 5 FAKRA-FAKRA	RFID-antenna-cable, L=5 m, IP40, FAKRA Z-coded to FAKRA Z-coded
52010451	R-AC 1 SMA-FAKRA	RFID-antenna-cable, L=1 m, IP40; FAKRA Z-coded to SMA (m); right-angle antenna plug
52010452	R-AC 3 SMA-FAKRA	RFID-antenna-cable, L=3 m, IP40; FAKRA Z-coded to SMA (m); right-angle antenna plug
52010453	R-AC 5 SMA-FAKRA	RFID-antenna-cable, L=5 m, IP40; FAKRA Z-coded to SMA (m); right-angle antenna plug
52010461	R-AC 1 TNC-FAKRA	RFID-antenna-cable, L=1 m, IP40; FAKRA Z-coded to TNC (m); right-angle antenna plug
52010462	R-AC 3 TNC-FAKRA	RFID-antenna-cable, L=3 m, IP40; FAKRA Z-coded to TNC (m); right-angle antenna plug
52010463	R-AC 5 TNC-FAKRA	RFID-antenna-cable, L=5 m, IP40; FAKRA Z-coded to TNC (m); right-angle antenna plug



52010174



52010250



52010598



52010527/528/529



52010461/462/463

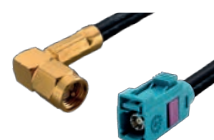

52010451/452/453



52010485/486/487/488

> Connection box

Order number	Name	Description
52010539	CB-A2	Advanced connection box; IP66, 230 V power supply unit, Ethernet, GPIO, AC breaker
52010540	CB-B2	Basic connection box, IP66, 230 V power supply unit, AC breaker
52010662	MK-CB-A2	Montage Kit for CB-A2 Connection Box Advanced
52010663	MK-CB-B2	Montage Kit for CB-B2 Connection Box Basic



52010540



52010539

> SMSH aluminum back wall

Order number	Name	Description
52010398	SMSH-BP-ALU	Aluminum back wall for SMSH



> Outdoor wall/pole mounting kit for RAIN RFID hardware

Order number	Name	Description
52010351	MK-WPM3-OSS Outdoor	Outdoor wall bracket
52010368	MK-PMA-OGV	Pole fitting extension for 52010351

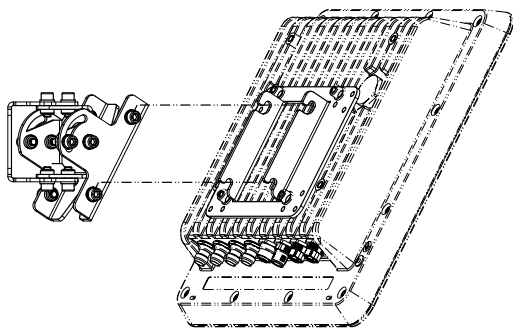

52010351

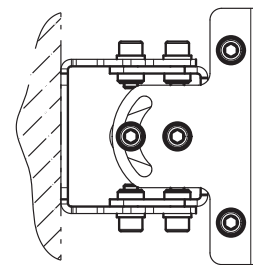

52010351/wall

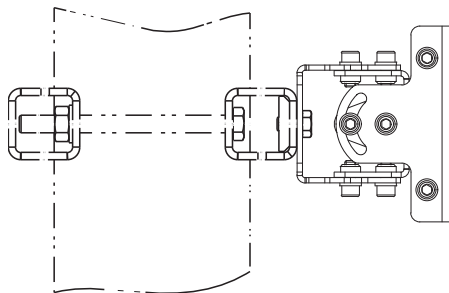

52010368/Pole mount adapter for 52010351

> Indoor wall mounting kit for RAIN RFID hardware

Order number	Name	Description
52010261	MK-WM-100-100-Indoor	Indoor wall bracket

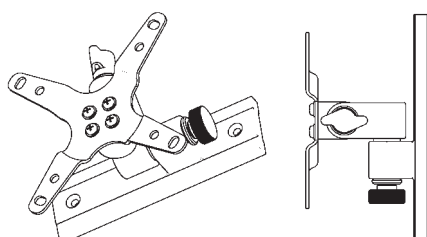

> **Vandalism protection for RRU 4000, ARU 3000, ARU 8500**

Order number	Name	Description
52010367	R-RVP3-VPP-SS	Vandalism protection for RRU 4000, ARU 3000

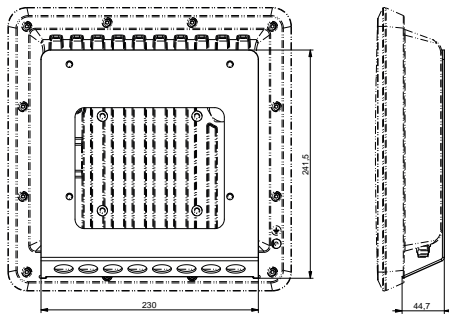

> **Shelf fitting kit for ARU 2400 Reader, WRA 6060 and WRA 7070**

Order number	Name	Description
52010479	MK-SHM-4IP	Shelf fitting kit for ARU 2400 Reader, WRA 6060, WRA 7070

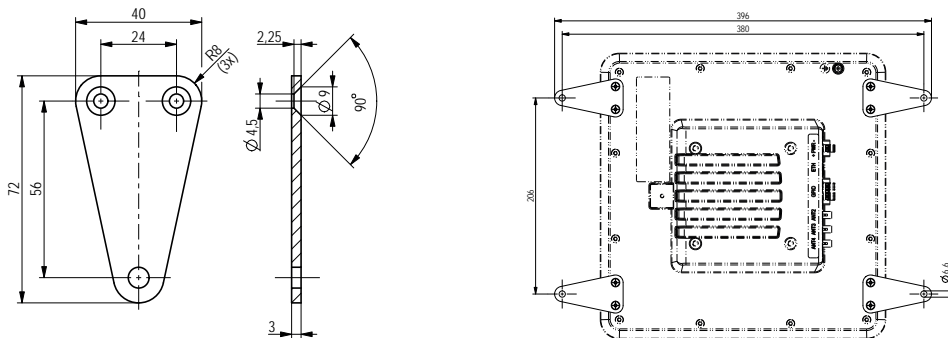



RAIN RFID software portfolio

Kathrein Solutions RFID portfolio with integrated Linux processor offers partners and customers the option to run Kathrein software variants or their own apps directly on the device.

> RFID software overview

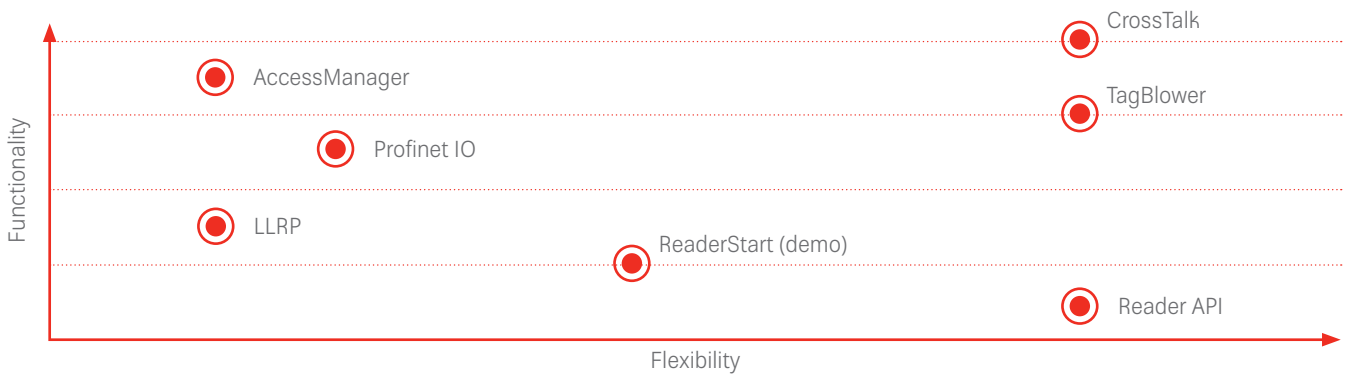

	CrossTalk	TagBlower app	ReaderStart (Demo)	Access manager	Profinet IO app	LLRP app	Reader API
Productive system	✓	✓		✓	✓	✓	
Configuration/test software			✓				
KBRP support	✓	✓	✓	✓	✓	✓	✓
CSV generation	✓	✓	✓				
Local file storage	✓	✓	✓				
HTTP data transmission	✓	✓					
White list handling	✓			✓			
Profinet					✓		
Device Management	✓						
MQTT Business Event	✓						
OPC-UA Client	✓						
XML / JSON generation	✓						
CloudReady	✓						
Areas of application	<ul style="list-style-type: none"> · Logistics · Healthcare · Automotive · Manufacturing · Supply chain · KanBan · ITS 	Automatic raw data transmission	<ul style="list-style-type: none"> · Configuration · Demonstration · Test 	Access control	Profibus applications	Low-level applications universal interface	Application development by partners

> CrossTalk software suite

As with all complex systems, the perfect interplay of hardware and software is of crucial importance. CrossTalk rises to this challenge extremely effectively and simplifies implementation of a wide range of RAIN RFID customer requirements and solution requests with no additional development effort.

CrossTalk is the easiest way to create the perfect AutoID solution. It supports partners and customers from the

PoC (proof of concept) through to global rollout with secure and reliable 24/7 operation of the physical AutoID layer.

The agent-based architecture of CrossTalk supports operation of several thousands of devices using different technologies in a distributed network environment. Plug-and-play setup for a wide range of devices and models made by standard AutoID manufacturers is already integrated.

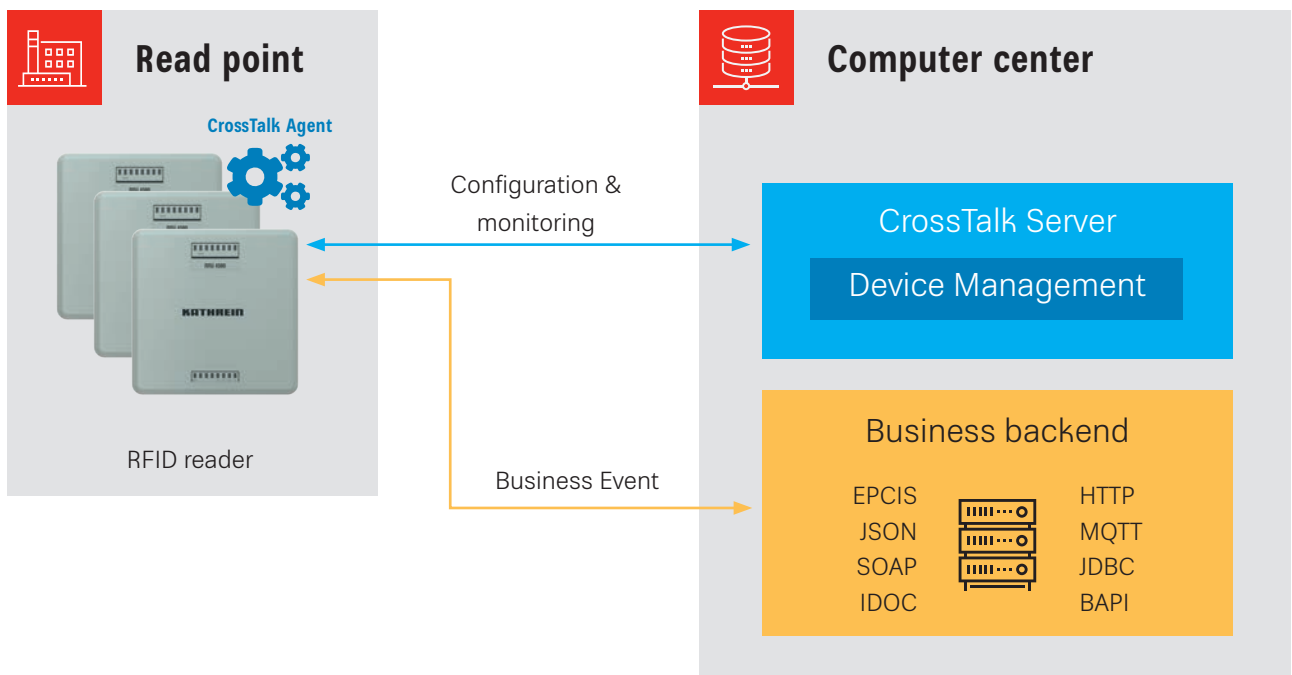

> Kathrein software: order overview*

Order number	Description
52010313	CrossTalk RFID license: Device Management Platform, AutoID Device Drivers, AutoID Process Toolkit, Infrastructure Application, Infrastructure Documentation, Rules Engine, 3rd Party Backend Integration - License per Logical ReadPoint
52010385	CrossTalk EPCIS repository: Event Repository, Capture & Query & Subscribe Features - License per Logical Read Point
52010317	CrossTalk support: 3rd-level support for 1 year - 20% of the license costs for the licenses used

*Available as one time purchase or yearly subscription model.

> CrossTalk Agent

The CrossTalk Agent edgware is Java-based and therefore runs on a variety of platforms. Each agent is given its individual functionality once by a central CrossTalk server entity. The agent, which is ideally operated directly on the device, carries out its processing activities completely independently from this server entity.

The CrossTalk server is then only responsible for monitoring the agents in the background. This decentralized distribution of the process functionality among the CrossTalk agents provides high failure security for the AutoID reading points.

With a large number of existing data structures and communications adapters in productive use, it is possible to supply various backend systems with valid business events quickly and reliably.

Core tasks of the edgware:

- Very easy integration of a wide range of AutoID manufacturers
- Real-time raw data processing
- Intelligent filtering of raw data
- Business event generation and transmission to the backend system

Event message encoders

- Puts AutoID data (RFID, RTLS, etc...) into the appropriate event format

Message senders

- Forwards the formatted events to the host system

Direct interfaces

- Formatted events are stored directly

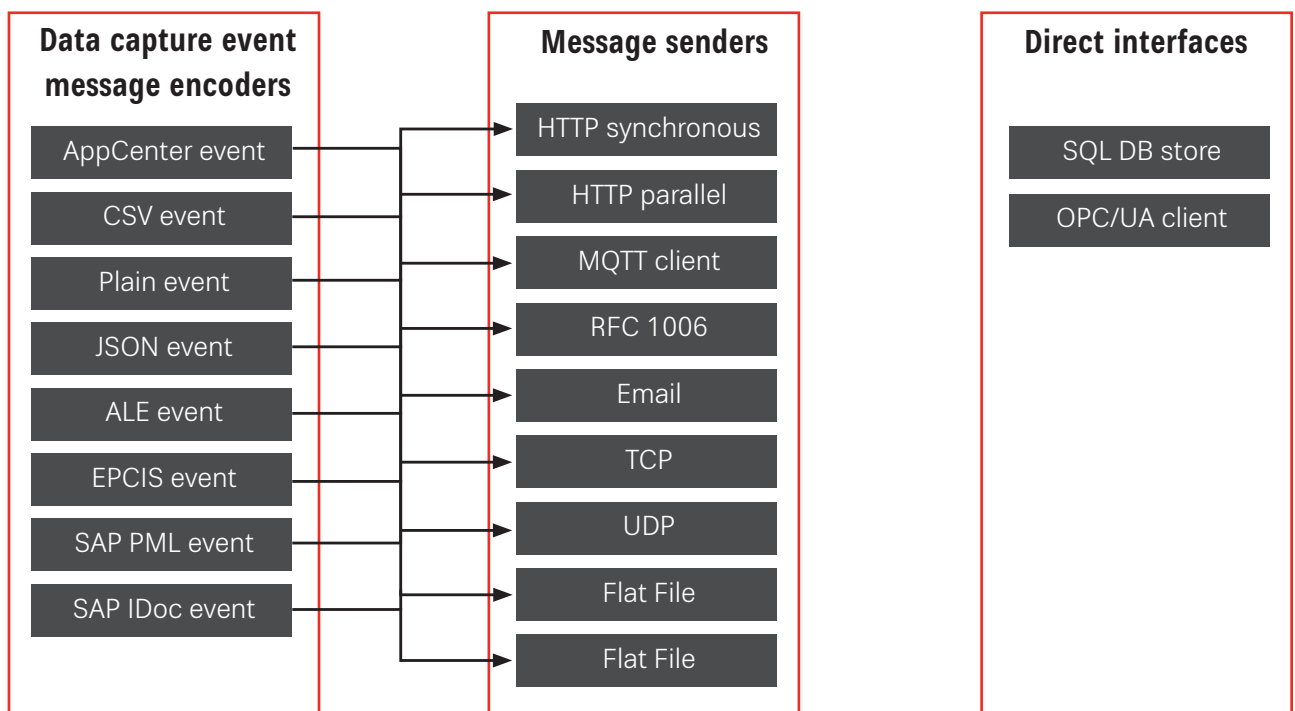

> CrossTalk Server

The central server entity can be operated either “on-premise” or in a cloud. All that is required for this is a Java application server and standard SQL database.

The device management application on the server allows complete control of the AutoID landscape with devices from different manufacturers.

Core tasks of device management:

- Organization and configuration of all CrossTalk Agents
- Monitoring and analysis of all functional modules in ongoing processes on the agents
- Design of process templates in a graphic designer on the basis of a large number of existing functional modules with no programming work
- Central distribution of updates (driver layer and functional modules)
- Simple rollout of a large number of agents and their processes, based on process templates already in existence
- Central alarm notification of maintenance teams if a functional module within the processes reports an error on the agent (email distribution, central REST call)

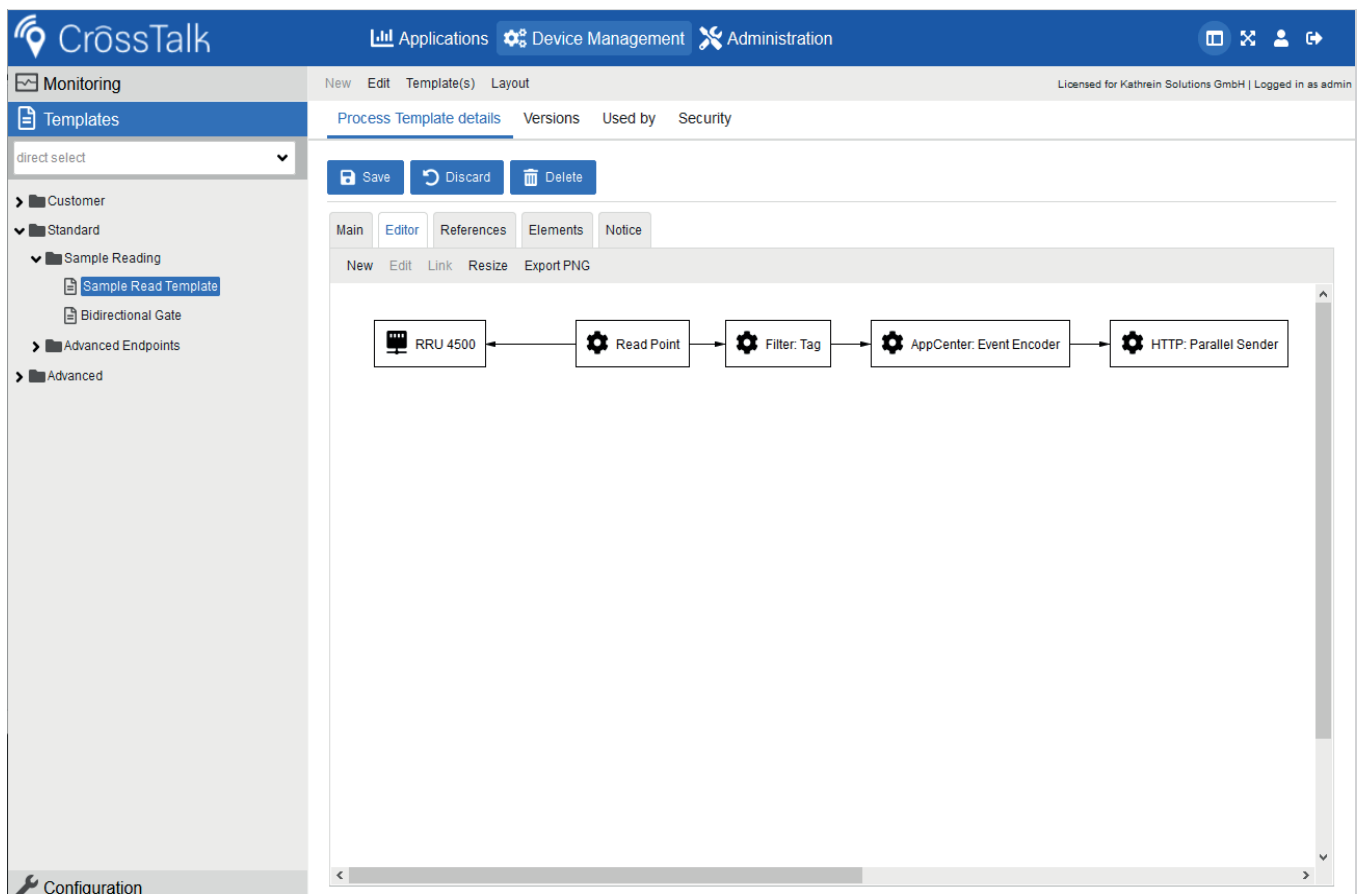

Graphical template designer for the device management application.

> Typical functional modules of a process template

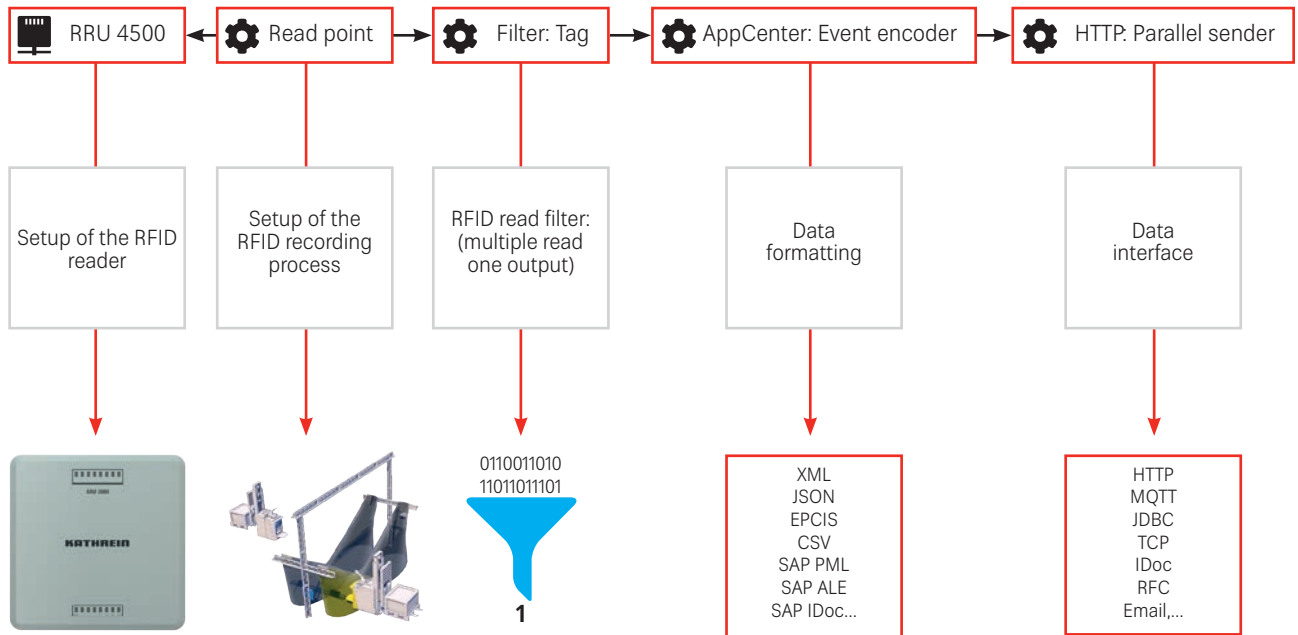

> CrossTalk Mobile

With our Mobile Application Framework (MAF), we are able to make various mobile applications available.

- Full support for Android mobile devices
- Simple device migration
- Access to existing modules
- Creation of smaller desktop or industrial PC terminal applications



Figure: M2Smart®SE mobile handheld computer

> Kathrein ReaderStart software

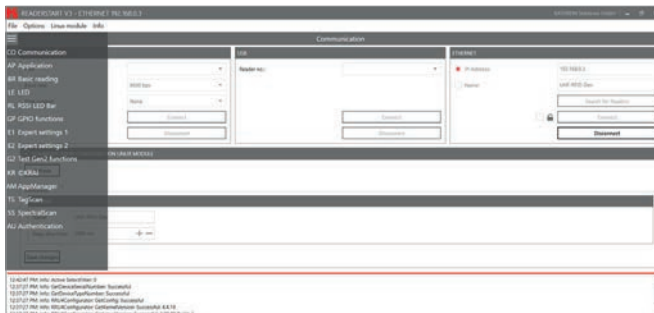

ReaderStart

Kathrein Solutions offers a configuration and test software named ReaderStart. Using predefined templates, such as gate applications or vehicle identification, the reader can be preset with the push of a button and an initial reading result is available quickly. Only a few more settings are then required to adapt it to the final environment.

> Kathrein reader application software

Profinet IO

The Profinet IO app allows integration of a reader into a Profinet IO environment. This is typical for applications in production and allows the reader to communicate with the production control system. The reader thus acts as an IO device and transmits the transponder data it reads directly to the connected PLC. The reader is therefore the perfect data source in this production environment.

Advantages:

- Industrial Ethernet standard
- Fast IO communication
- High data rate

TagBlower

The TagBlower app is a simple application that makes it possible to distribute data quickly in a defined way. The data read are stored automatically at a predefined port and can be accessed and picked up by an external listener. In addition to the data read, status messages (e.g. "Transponder approaching") can also be issued. This range of data and status messages can be customized. Data can therefore be captured in simple applications or early in the realization phase.

Advantages:

- Multiple listeners
- Push notifications
- Configurable

LLRP

The LLRP app from Kathrein Solutions allows for standard communication of basic commands and data between the RFID reader and a piece of application software with a standard protocol from EPCglobal. This app runs on the Linux IPC in the reader and connects to an LLRP controller. The supported standard is LLRP 1.0.1 and the defined transmission port 5084

Advantages:

- Standardized commands
- Universal data and configuration interface
- Standard transmission port 5084

> Kathrein reader application software

AccessManager

The AccessManager app from Kathrein Solutions combines RFID reading results with digital input and output signals (GPIO) and makes decisions on that basis. As a result, anything from access authorizations at parking garage barriers to sorting systems for containers can be managed autonomously. The starting point is an input signal from a light barrier or a sensor, which is read by a digital input on the reader. This starts an automatic process which reads transponder data and takes decisions on the basis of a predefined white list. These decisions can be sent to digital outputs immediately to

operate conveyor belt switches or parking barrier relays. Additionally, the LEDs on the reader can be activated to give the user visual feedback on the process.

AccessManager allows rules to be created easily in the Linux operating system without any programming knowledge. In addition to the authorizations recorded, each reading event can be stored in a log file. The participant identification and precise time are recorded in an SQLite database. This information can be retrieved for a set period, with access via a remote connection or locally as a CSV or XML file.

Kathrein software: order overview

Order number	Name	Description
52010375	ProfiNet app software	for all Kathrein readers
52010381	TagBlower app software	for all Kathrein readers
52010217	AC-Manager software	for all Kathrein readers

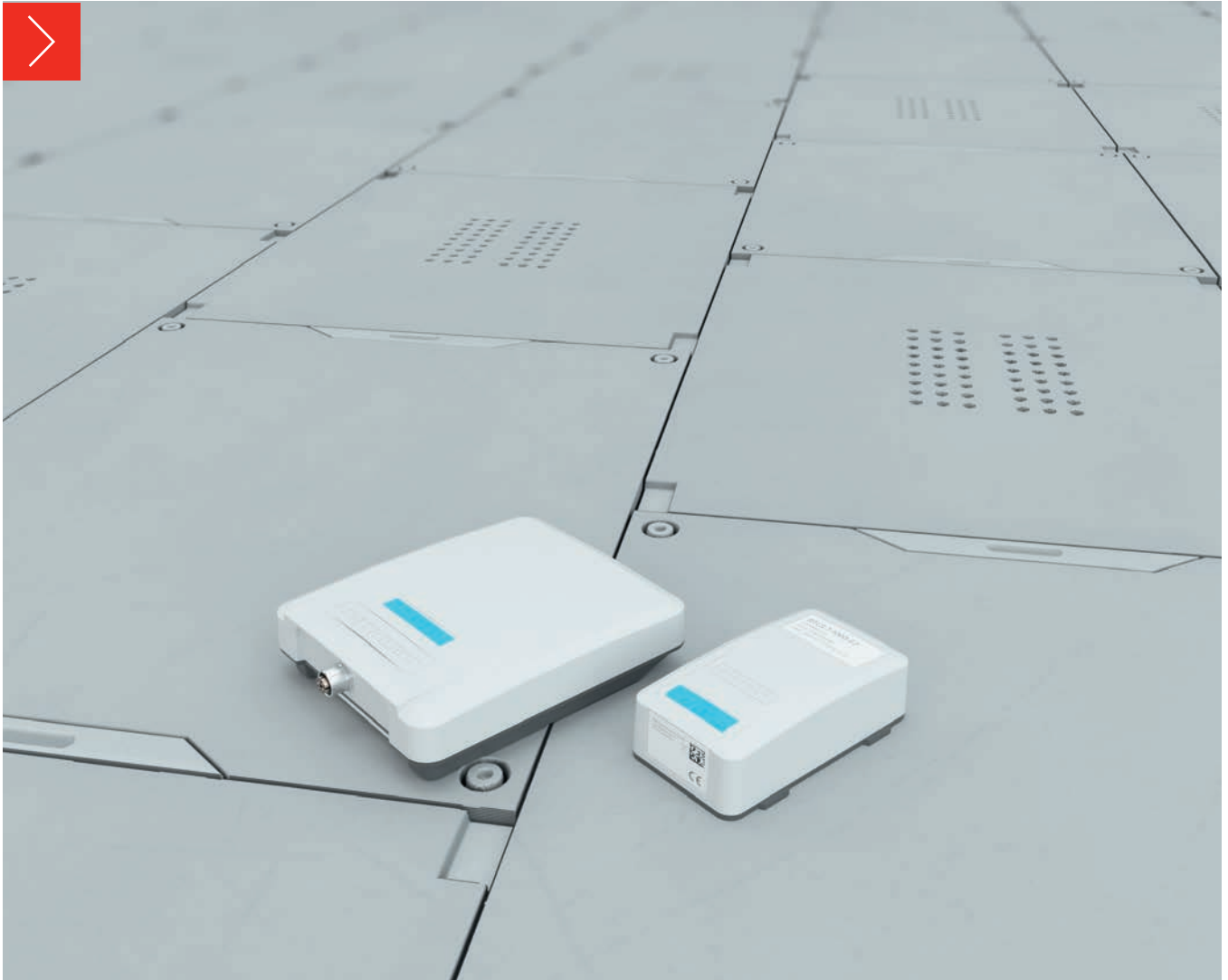

K-RTLS hardware

Kathrein Solutions, “K-RTLS” real-time localization system combines high localization accuracy in the industrial environment with unique technical properties that allow broad use in a wide variety of applications. Precise monitoring of the progress of manufacturing in the production environment or transparent material flow in intralogistics are only two of many possible applications. The real-time data available about the location and condition of objects with the K-RTLS form the basis for networking of processes in the value creation chain.

> K-RTLS overview

Two parameters are always in the foreground with localization applications, Localization accuracy and frequency. There are some applications that require precise determination of position. Here, the end position of a movement is recorded with high accuracy. This is used, in particular, for movements within the warehouse or in production. The alternative is constant recording of the travel, with slightly less precise intermediate values – however, this does allow fast evaluation

of the route or travel range (heat map).

In particular, this mode is used when switching between recording areas, e.g. for movements from production to the warehouse. Because these two modes may not be allowed outdoors, Kathrein has introduced the Angle of Arrival mode for such application.

All three modes are supported by the K-RTLS solution from Kathrein Solutions.



Highly dynamic RTLS: Time of Flight (ToF), accurate up to 75 cm.

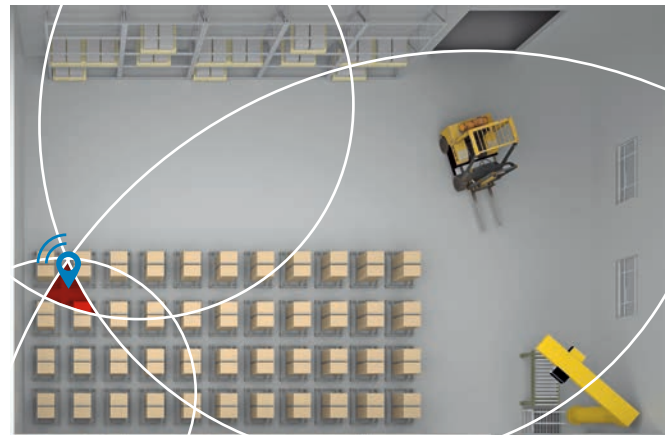

High-precision RTLS: Two-way ranging, accurate up to 25cm.

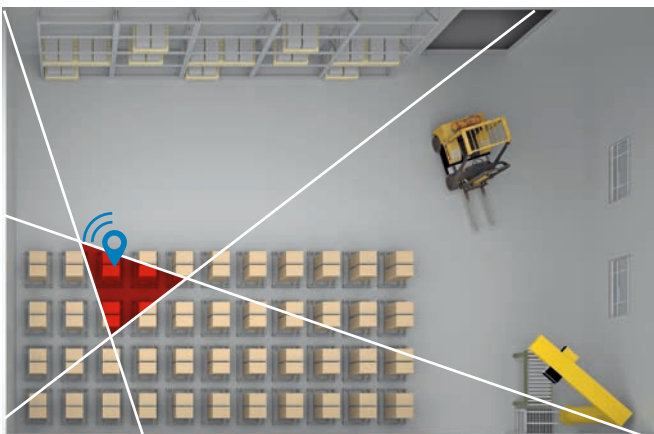

Outdoor Modus RTLS: Angle of Arrival accurate up to 100cm

> K-RTLS transponder

Kathrein Solutions' RTLS-T-1000 real-time locating system transponder offers a localization accuracy of up to 25 cm. Two operating modes are available. The Time of Flight (ToF) mode provides very high localization accuracy, while the Time Difference of Arrival (TDoA) mode for dynamic applications is characterized by very long battery life. The unique combination of UWB (Ultra Wide Band) with RAIN-RFID and NFC technology in a robust IP67 housing allows simple, seamless integration into an existing AutoID infrastructure. The RFID UHF tag is used for detection in the range up to 10 m, while the RFID-NFC tag can be used for near-field detection and smartphone communication simply to read data or overwrite existing values.

A K-RTLS node can also be used in a type of transponder mode. The node can then work as a transponder and its position reported to other nodes. This is used, for example, when an industrial truck has to be tracked continuously and its battery can be used as a power supply for the node.



Name	53010002	53010001
Order number	RTLS-T-1000-67	RTLS-N-1000-67*
UWB localization		
Frequency range [MHz]	3244-6999	
Transmit power at the antenna [dBm]	-41.3	
Input sensitivity [dBm/500MHz]	-93 to -106/500 (1% packet error rate)	
Coverage [m]	approx. 80 in the line of sight	
Standards	IEEE 802.15.4 UWB, EN301489-3, EN50364, EN62368-1, EN60529	IEEE 802.15.4 UWB, EN301489-3, EN50364, EN62368-1, EN60529, FCC Part15, UL, IC
RFID UHF		
Frequency range [MHz]	860-960	-
Connection	I ² C	-
Standards	ISO 18000-6C (Gen2); ISO 18000-64 (TOTAL)	-
RFID NFC		
Frequency range [MHz]	13.56	-
Connection	I ² C	-
Standards	ISO/IEC 14443, Part 2 and Part 3	-

* The RTLS node can also be used as a transponder by software command.

> K-RTLS transponder

Order number	53010002	53010001
Name	RTLS-T-1000-67	RTLS-N-1000-67*
Power supply		
Type	Battery** (CR123A (EIC-CR17345), exchangeable)	PoE+, local supply
Battery capacity [Ah]	1.5	-
Rated voltage [V]	3	-
Typ. battery life (at min. requirements)	> 5 years***	-
Connection	-	M12, X-coded, 8-pin, female
Remote power supply	-	PoE+ according to 802.3af (10-57)
Power supply consumption [W]	-	2.5
Remote power supply consumption [W]	-	IEEE 802.3af PoE Class 0; 0.44-12.06
LED visualization		
Status display	1 multi-color LED	
Mechanical properties		
Protection class	IP67	
Operating temperature range [°C]	-40 to +50	
Storage temperature range [°C]	-40 to +85	
Dimensions (L x W x H) [mm]	92 x 54 x 30	160x135x37

* The RTLS node can also be used as a transponder by software command. ** The battery is an accessory and is not supplied.

*** Depends on update rate, localization accuracy and period of use.

Accessories

Order number	Description
53010003	RTLS-T-MPC support plate for transponder assembly
53010007	RTLS-T battery, CR123A (EIC-CR17345), 12-pack
52010006	RTLS-N node wall/pole fitting set

> K-RTLS node

Kathrein Solutions RTLS-N-1000 real-time locating system node sets a new IoT standard for location and tracking solutions. The node is installed as a fixed anchor and serves as a reference and measurement point for the transponders involved. All of the nodes involved in the process deliver their localization results to CrossTalk or an evaluation software package based on the Kathrein RTLS API. In Time of Flight mode (ToF), the location is determined with high precision. In time difference of arrival mode (TDoA), the current position of the transponder is detected and this intermediate position is tracked continuously to create a movement profile. Angle of Arrival (AoA) mode is used for outdoor applications

Transponder mode is another operating mode of the node. The node can then work as a transponder and reports its position to other nodes.



Name	53010000	53010001
Order number	RTLS-N-1000-40	RTLS-N-1000-67
UWB localization		
Frequency range [MHz]	3244-6999	
Transmission power at the antenna [dBm]	-41.3	
Coverage [m]	approx. 80 in the line of sight	
Standards	IEEE 802.15.4 UWB, EN301489-3, EN50364, EN62368-1, EN60529, FCC Part15, UL, IC	
2.4-GHz communication link		
Frequency range [MHz]	2400-2483.5	
Standards	IEEE 802.15.4:2006, IEEE 802.15.4:2011, IEEE 802.15.4:2012, IEEE 802.15.4:2015	
Ethernet		
Number of Ethernet connections	1	
Connection	RJ45	M12, X-coded, 8-pin, female
Voltage		
Typ	PoE+, Local supply	
Connector	M 12, X-coded, 8-pin, female	
Remote power supply	PoE+ according to 802.3af (10-57)	
Power supply consumption [W]	2.5	
Remote power supply consumptions [W]	IEEE 802.3af PoE Class 0; 0.44-12.06	
LED visualization		
Status display	1 multi-color LED	
Mechanical properties		
Protection class	IP40	IP67
Operating temperature range [°C]	-40 to +50	
Storage temperature range [°C]	-40 to +85	
Dimensions (L x W x H) [mm]	160 x 135 x 37	

> K-RTLS accessories

Order number	Name	Description
53010006	RTLS-N-WPM	RTLS-N node wall/pole fitting set
53010003	RTLS-T-MPC	RTLS-T support plate for transponder assembly
53010007	RTLS-T-BAT	RTLS-T battery, CR123A (EIC-CR17345), 12-pack
52010474	R-PRA 24DC-18W	AC/DC power supply unit 24 V/18 W, AC 110–230 V, mains plug device, replaceable AC plug

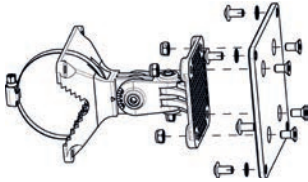

53010006

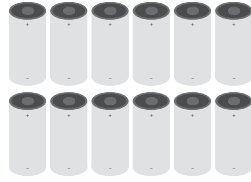

53010007



52010474



53010003



K-RTLS software

Kathrein Solutions offers partners and customers the opportunity to implement the K-RTLS system with the API provided or allows rapid entry to the world of RTLS with the aid of the CrossTalk productive solution.

> RTLS software overview

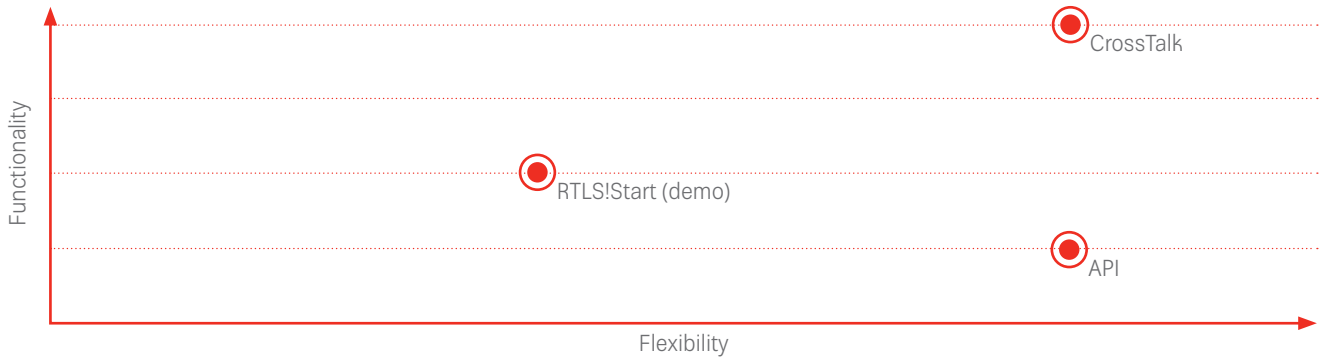

	CrossTalk	RTLS!Start (Demo)	K-RTLS Positioning API
Productive system	✓		
Configuration/test software		✓	
KSRP support	✓	✓	✓
CSV generation (saving raw data in CSV format)	✓	✓	
HTTP data transmission	✓		
Device Management	✓		
MQTT Business Event	✓		
XML generation (saving raw data in XML format)	✓	✓	
JSON generation	✓		
CloudReady	✓		
Areas of application	<ul style="list-style-type: none"> · Logistics · Healthcare · Automotive · Manufacturing · Supply chain · KanBan 	<ul style="list-style-type: none"> · Configuration · Demonstration · Test 	Application development by partners

> CrossTalk software suite

As with all complex systems, the perfect interplay of hardware and software is of crucial importance. CrossTalk rises to this challenge extremely effectively and simplifies implementation of a wide range of RTLS customer requirements and solution requests with no additional development effort. CrossTalk is the easiest way to create the perfect localization solution. It supports partners and customers

from the PoC (proof of concept) through to global rollout with secure and reliable 24/7 operation of the physical AutoID layer. The agent-based architecture of CrossTalk supports operation of several thousands of devices using different technology in a distributed network environment. Plug-and-play setup for a wide range of devices and models made by standard AutoID manufacturers is already integrated.

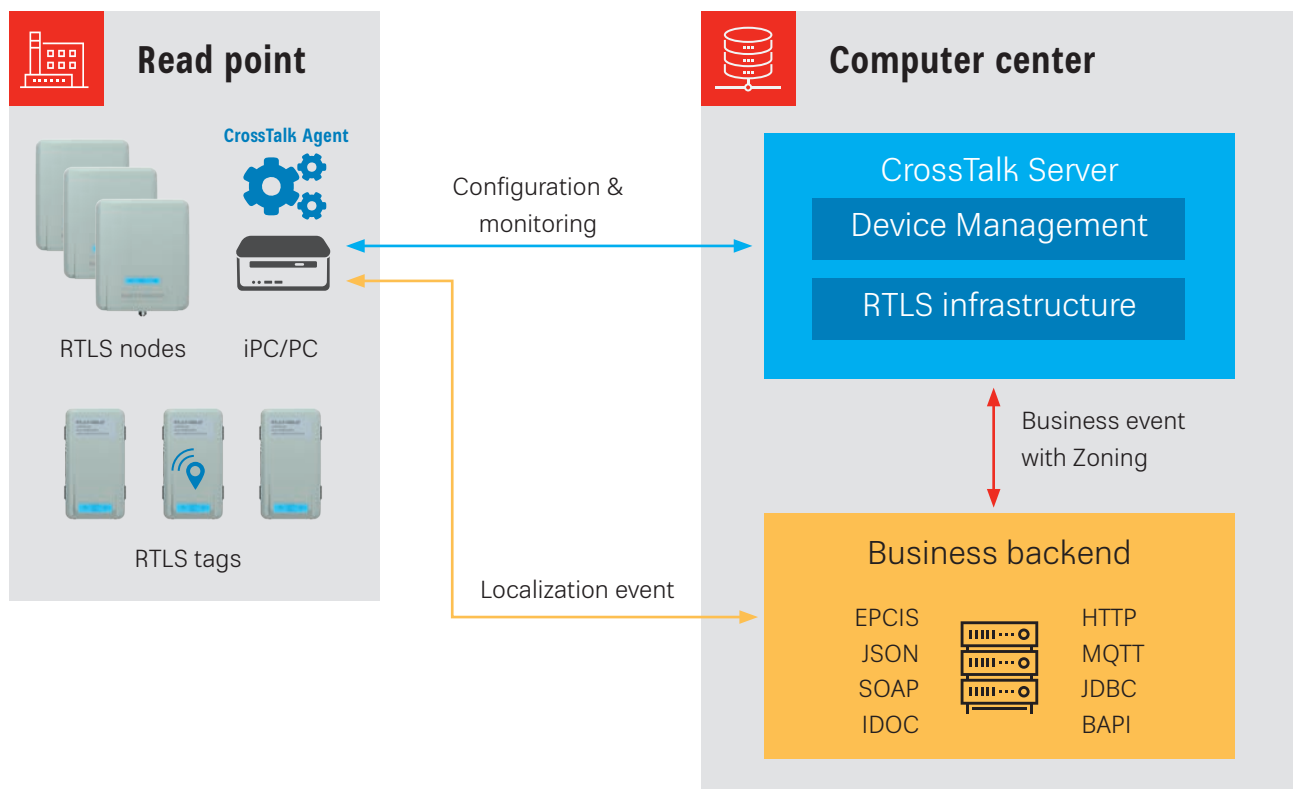

> CrossTalk Agent

- Localization on a local IPC or PC
- Configuration of node and tag
- Calculation of the tag position by means of the measurement data from the nodes
- Filtering and buffering of the tag position data

> CrossTalk Server

- Visual zone editor
- Geo-localization and geo-fencing
- Repository for the RTLS device configuration
- Monitoring of the devices and functional modules
- Zone allocation events are sent directly to the business backend
- Many interface adapters ready for immediate use

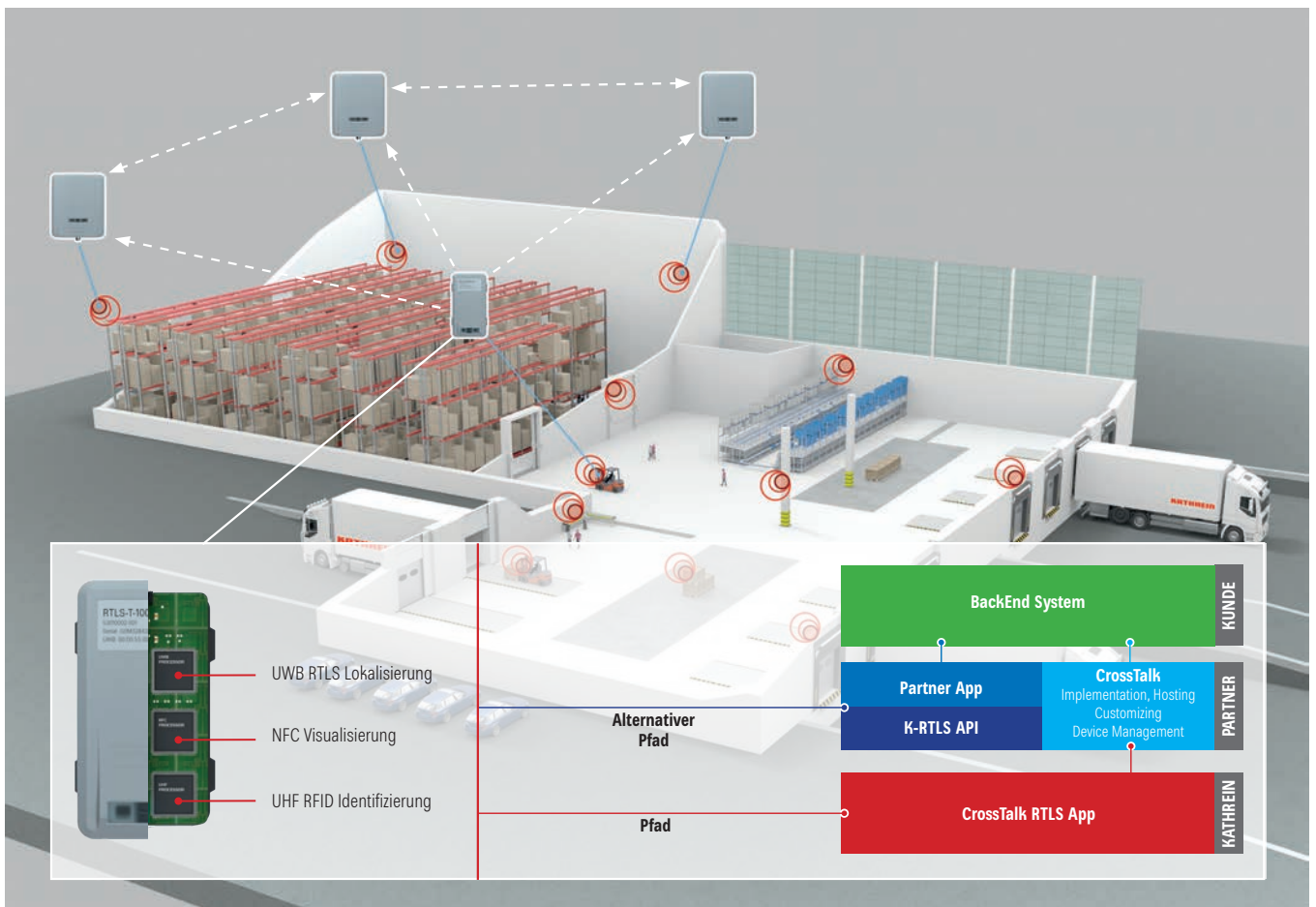

> RTLS infrastructure application

The RTLS infrastructure application on the server is the link between the physical AutoID device layer and the business logic of the backend system.

- Creates any location hierarchy using location, range and zone elements
- Visual objects in geo-based and layout-based maps
- Visual location editor for loading and calibrating maps, drawing and moving zones
- Defines the tolerance of the zone limits and the geo-fencing to prevent an unwanted change of zone
- Deals with the localization events of active RTLS systems and passive RFID solutions
- Defines fixed reading points as positioning marks and gate movements (RFID)
- Forwards logical localization events as business events to other apps or backend systems

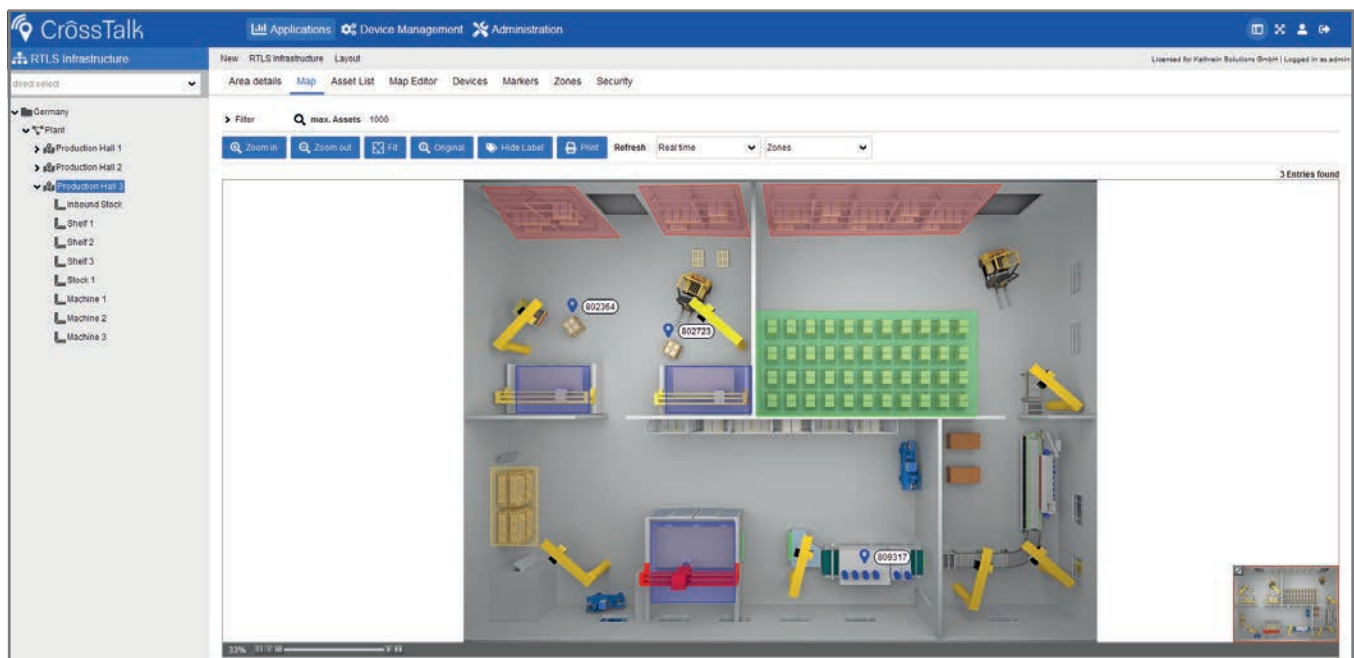

Visual zone editor of the RTLS infrastructure application.

> RTLS!Start

Kathrein provides the RTLS!Start tool free of charge for commissioning and testing RTLS components. It allows the operating mode to be set for the nodes and transponders and all the settings to be saved. All the spatial parameters and all the HF properties can be configured. All localization results can also be recorded and logged. Installation and commissioning of the system is therefore easy. Nothing more than a laptop and a yardstick is required.

We recommend CrossTalk software for operation of a Kathrein RTLS system. This controls the nodes involved and compiles the reading results. These functions are also available as an API for easy development of customized solutions.

The functions and operating modes described previously are available with both CrossTalk and software solutions based on the Kathrein API.

> Kathrein software: Order overview*

Order number	Description
53010011	CrossTalk RTLS license: RTLS Device Management Platform, RTLS Infrastructure Application, Infrastructure Documentation, Positioning Engine, Rules Engine, 3rd Party Backend Integration - License per RTLS Node
52010385	CrossTalk EPCIS repository: Event Repository, Capture & Query & Subscribe Features - License per Logical Read Point
52010317	CrossTalk support: 3rd-level support for 1 year - 20% of the license costs for the licenses used

*Available as one time purchase or yearly subscription model.



Professional services

The extensive foundation of the Kathrein Solutions IoT portfolio is available to its partners within the KATHREIN partner ecosystem and the end customers at any time and in all phases of the project.

The Professional Services team ensures successful project implementation with its pre-sales, consulting, project management and training academy services. In addition, Professional Services is available via 3rd level software support to ensure the availability of the systems installed in the field.

This leads to highly efficient and competent order acquisition as well as successful project implementation.



> Overview of professional services

The multitude of conceptual possibilities based on the Kathrein Solutions portfolio is the basis for meeting all application requirements within the scope of identification and localisation projects.

The modularity of professional services and partner-oriented orientation of Kathrein Solutions offers maximum flexibility.

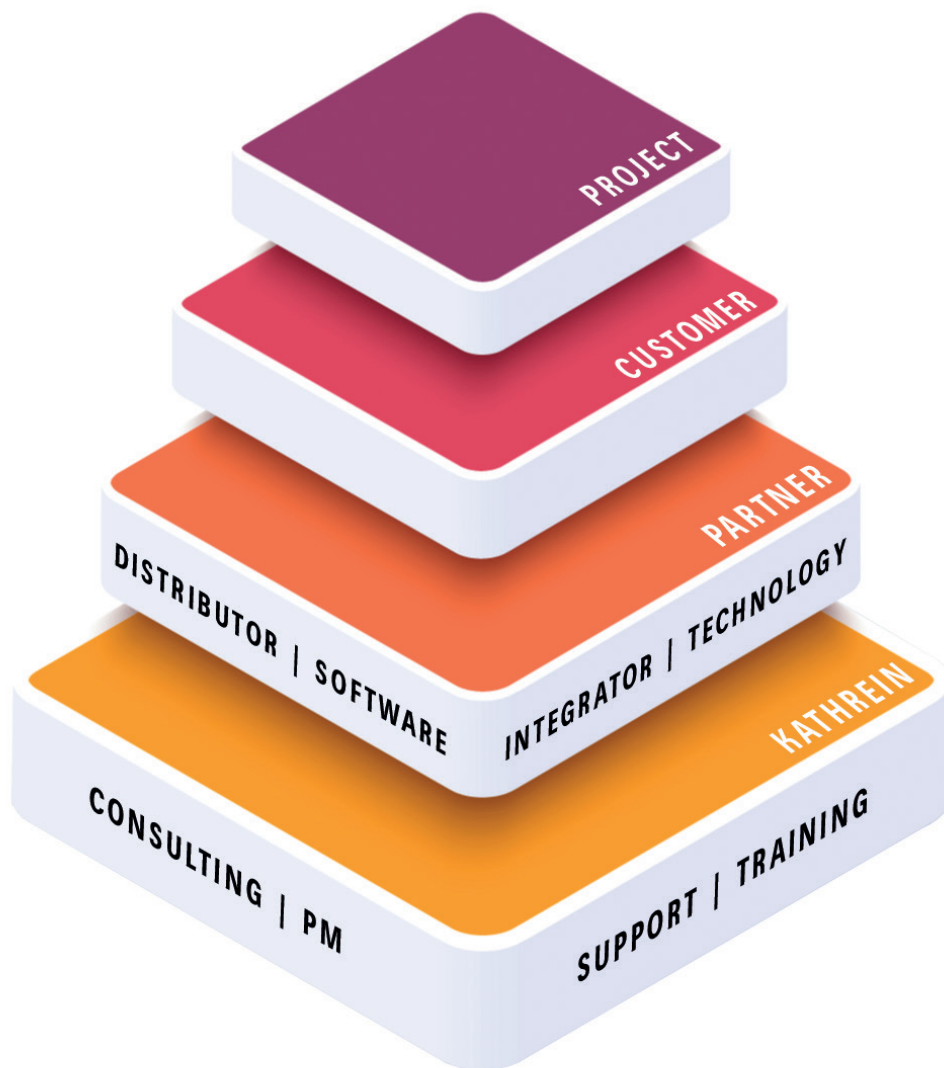

> Consulting

Technology consulting directly from the experts

Our experienced, multidisciplinary team of consultants offers you individual advising to move your project forward with the right solutions.

With a multitude of projects successfully completed in a wide range of industries, we can apply our expertise in the areas of RFID and RTLS to any phase of the project you like.

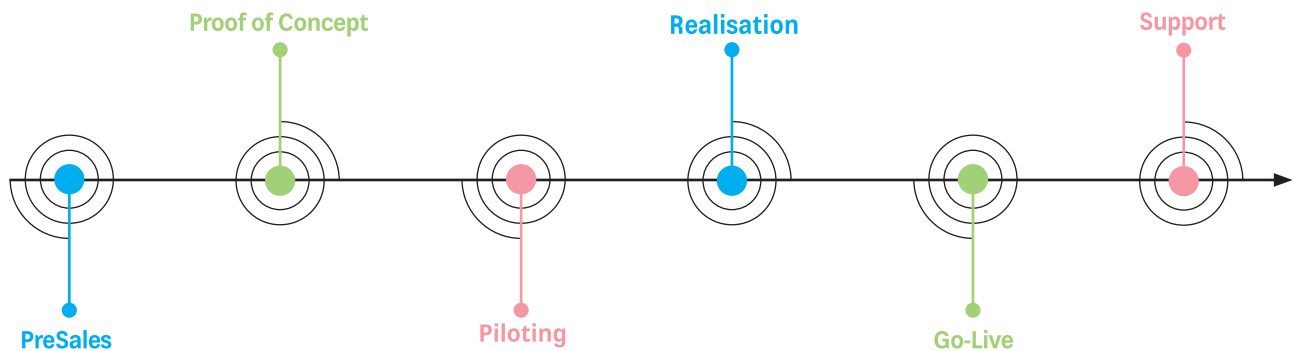

Through the combination of your industry knowledge and experience of your day-to-day business and our expertise in technology and experience from a large number of projects, we are able to work with you to develop a concept that suits your digitization strategy. We play to our strengths in both theory and practice. But the starting point is always your idea, and we begin by listening. We discuss your idea together and refine it into a solution concept through our approach to consulting. Then we set out a common solution pathway together to turn your idea into a practical application. Various tried-and-tested methodologies and approaches are available to us here:

- Software-based simulations of individual systems
- Application-based transponder qualification including coding scheme
- Process analysis and optimization through workshops
- Process-based selection of suitable products (hardware & software)

- Application-based feasibility study (PoC) in our Test Center
- Realistic feasibility study (PoC) in your company
- Transponder calibration in our measurement chambers
- Process assurance through pilot operation with analysis/evaluation of live data
- Template design for CrossTalk applications
- CrossTalk installation and configuration consulting
- Interface integration/management
- Raw data analysis of the completed application

The key to our success is our holistic consideration of the various system parameters, both those that are obviously relevant and those that may, at first sight, appear unimportant. We customize our solution portfolio of hardware, software and services to meet your requirements so that we can offer you maximum quality and performance in every phase of your project.

> Consulting order overview

Order number	Name	Description
52010321	Blueprinting services	We carry out a feasibility study to check your approach to the project, select the best technology for it and determine the estimated project costs. We develop a customized concept for you based on these findings. We provide you with relevant information so that you can make the most effective decision about your project on a sound basis and with an eye to the future.
52010330	Documentation	A crucial factor in the success of planned projects is transparent documentation in accordance with the amount of work involved. We ensure that all the work packets are properly documented in full.
52010323	Application Engineer (HF & Field Analysis)	Our consulting managers form the core of the department. From consulting and planning activities to realization and acceptance, our team is at your disposal.
52010138	Test Center & engineer support	Our Kathrein Test and Application Center makes it possible to evaluate ideas and concepts in advance for reliable concept workshops and effective physical tests in a simulated real environment. This avoids any disruptions to your productive operations.
52010572	General support	If you require general hardware and/or software support from our consulting team for a specific period, we'll give you the option of booking a support package.
52010569	Travel time	Time for return travel
52010570	Travel costs	Individual costs, such as air/train ticket, subsistence allowance, car rental, etc.
52010571	Overnight accommodation	Hotel costs, etc.

> Project management

“Tell me how your project starts and I’ll tell you how it ends.”

Make the most of our many years of expertise in project management to implement your projects successfully. As an official Kathrein partner or allocated key customer, you can look forward to planning and delivering your projects with our certified project managers. In projects, as in consulting, our approach is to listen. In the spirit of the heading, we align our own project management process with RFID and RTLS projects.

Depending on the project size, duration and degree of complexity, we work with you to choose the model we will use for your project in accordance with the project management handbook specially developed for it. The finishing touch to the project work is provided by our use of the latest software (e.g. Microsoft Project, easyREDMINE) to give you maximum transparency in relation to time, costs and quality.

The graphic below shows our most popular, most flexible model for delivering medium-sized projects.

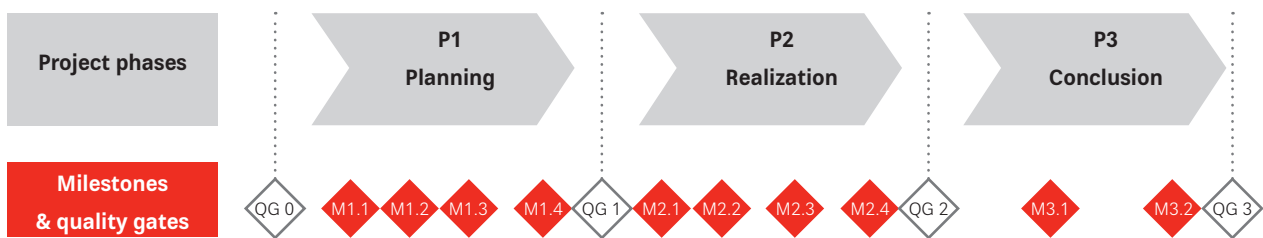

With our approach to project management, we aim to achieve the best possible distribution of resources and experts in our project landscape for the Kathrein team assigned to you.

Our certified project managers are available to you as main contacts or escalation authorities throughout the project, depending on the type of commission.

> Project management order overview

Order number	Name	Description
52010322	Project management	Our certified project managers ensure that your project is planned, controlled and concluded transparently and effectively throughout the duration of the project.
52010330	Documentation	A crucial factor in the success of any project is transparent documentation in accordance with the amount of work involved. We ensure that all the work packages are properly documented in full.
52010325	Hardware installation/assembly	Depending on complexity, we decide either to install the reading points ourselves or to appoint our established installation partners to do so.
52010316	Software installation/configuration	You decide whether you'd prefer to do this yourself, require our support for some of it or leave it entirely to us (assuming there is remote access).
52010315	Software customizing/development	If your project differs from the standard, we are happy to offer you customization in our software landscape.
52010323	Application Engineer (HF & Field Analysis)	Our consulting managers form the core of the department. From consulting and planning activities to realization and acceptance, our team is at your disposal.
52010324	Integration test	Structured, successfully completed test phases are the prerequisite for smooth commissioning. With our generic test model (basic, functional and measurement tests), we are happy to support you along the way.
52010329	Go-live support	We are available to you as a sparring partner for a defined period after commissioning in order to make your start-up as easy as possible.
52010569	Travel time	Time for return travel
52010570	Travel costs	Individual costs, such as air/train ticket, subsistence allowance, car rental, etc.
52010571	Overnight accommodation	Hotel costs, etc.

> Training

KATRAC – 6 letters that stand for our KATHREIN Training Academy.

We have set ourselves the aim of combining our RFID and RTLS expertise with our own Kathrein product and solution portfolio to allow us to develop your personal expertise. We are certain that this extra knowledge will give you the edge in terms of time, costs and quality when it comes to delivering your own or our joint projects. We are experts in our field – and we also enjoy turning you into experts, too.

Our modules are so flexible that we can offer everyone new ways of developing their knowledge, from inexperienced rookies to those with many years of experience. Beyond the standard modules, we will be happy to take the time to plan and deliver an individual training course for you, customized to your needs. We also offer you various ways of providing the training.

Choose your preferred variant:

- an in-house course
- a course on our premises in Stephanskirchen (including the Test Center)
- or online by video conference.

The graphic provides an overview of our modules. We're sure to have the right course for you, no matter your areas of interest (sales or technical focus).

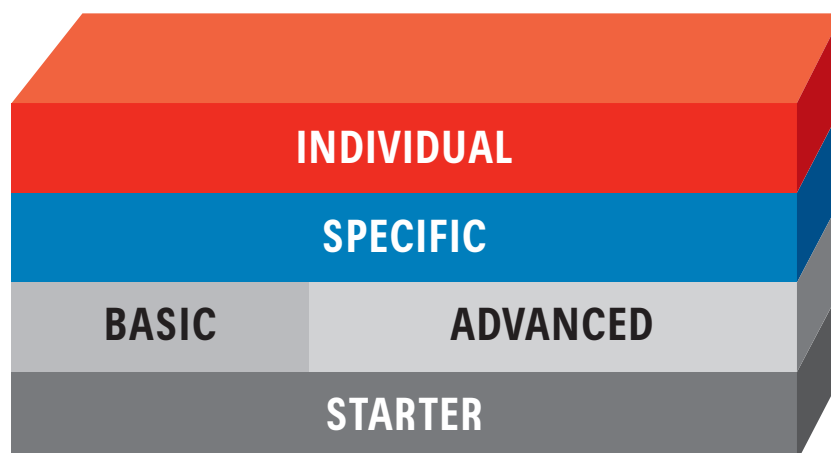

> Training order overview

Order number	Name	Description
52010665	KATRAC - BASIC Training	Our BASIC Module opens the door to the world of UHF RFID. With both training days we focus on theoretical basics and practical usage with the solution portfolio of Kathrein Solutions GmbH.
52010666	KATRAC - ADVANCED Training	Our ADVANCED Module is for users with basic knowledge of UHF RFID. With both training days we focus on conveying expert knowledge and advanced practical usage with the solution portfolio of Kathrein Solutions GmbH.
52010667	KATRAC - SPECIFIC Training	Our SPECIFIC module can be designed according to your wishes for specific single applications, which are only cut or not included in the BASIC or ADVANCED module. The training concept is drawn up in advance in joint coordination.
52010668	KATRAC - INDIVIDUAL Training	Our INDIVIDUAL module is our most flexible component. In close coordination, for example, an individual training plan can be created or we accompany you individually in your own project via training-on-the-job.
52010569	Travel time	Time for return travel
52010570	Travel costs	Individual costs, such as air/train ticket, subsistence allowance, car rental, etc.
52010571	Overnight accommodation	Hotel costs, etc.

> Support

Support – for all phases of your project

Our versatile support is the final module, rounding off our current service portfolio for you. In addition to specific content, such as consulting, project management and

the Training Academy, we also offer you a wide range of support options.

Decide for yourself how you want to utilize them.

Here are a few suggestions:

- Support package (person days)
- CrossTalk software maintenance contract (3rd level)
- Support contract (term-based)
- Standard support for Kathrein partners
- Ticketing portal
- Download portal
- Hardware repair service
- Go-live support (see also Project management)

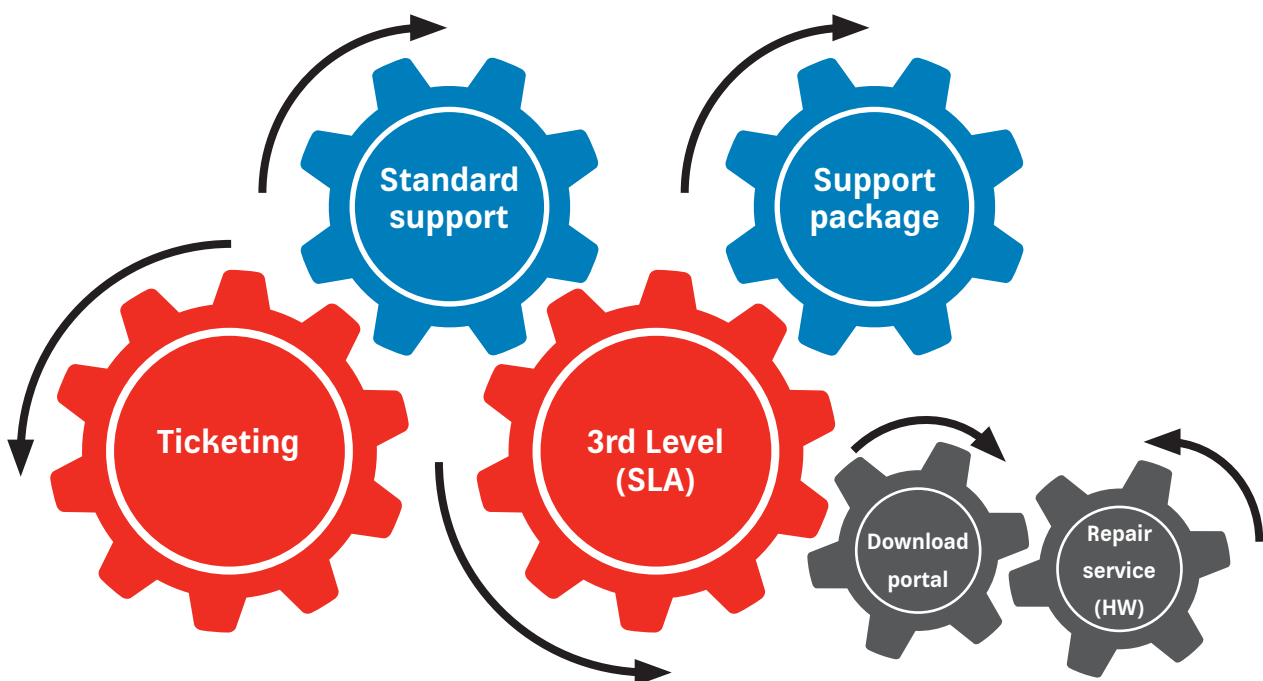

> Support order overview

Order number	Name	Description
52010572	General support	person days over a set period
52010317	Software maintenance contract	CrossTalk 3rd-level remote support with a term of one year
52010569	Travel time	Time for return travel
52010570	Travel costs	Individual costs, such as air/train ticket, subsistence allowance, car rental, etc.
52010571	Overnight accommodation	Hotel costs, etc.

> Ticketing process

If you have technical questions, you can simply send us a ticket by email.

Contact: support@kathrein-solutions.com

Regardless of whether your questions relate to our hardware or software applications, they will be forwarded to the appropriate specialist in our support team, who will promptly deal with your enquiry.

You can also find this address on our homepage via the "Support" tab:

www.kathrein-solutions.com/de/support/ticketing-system

Overview of your Advantages

- Easy creation of a ticket by email including automatic confirmation of receipt
- High availability during working hours using our central mailbox
- Uniform incoming inspection and content-oriented distribution to the appropriate expert
- Continuous and automated tracking of your tickets so that nothing is left behind
- Complete documentation of all actions within the ticket (mail history)

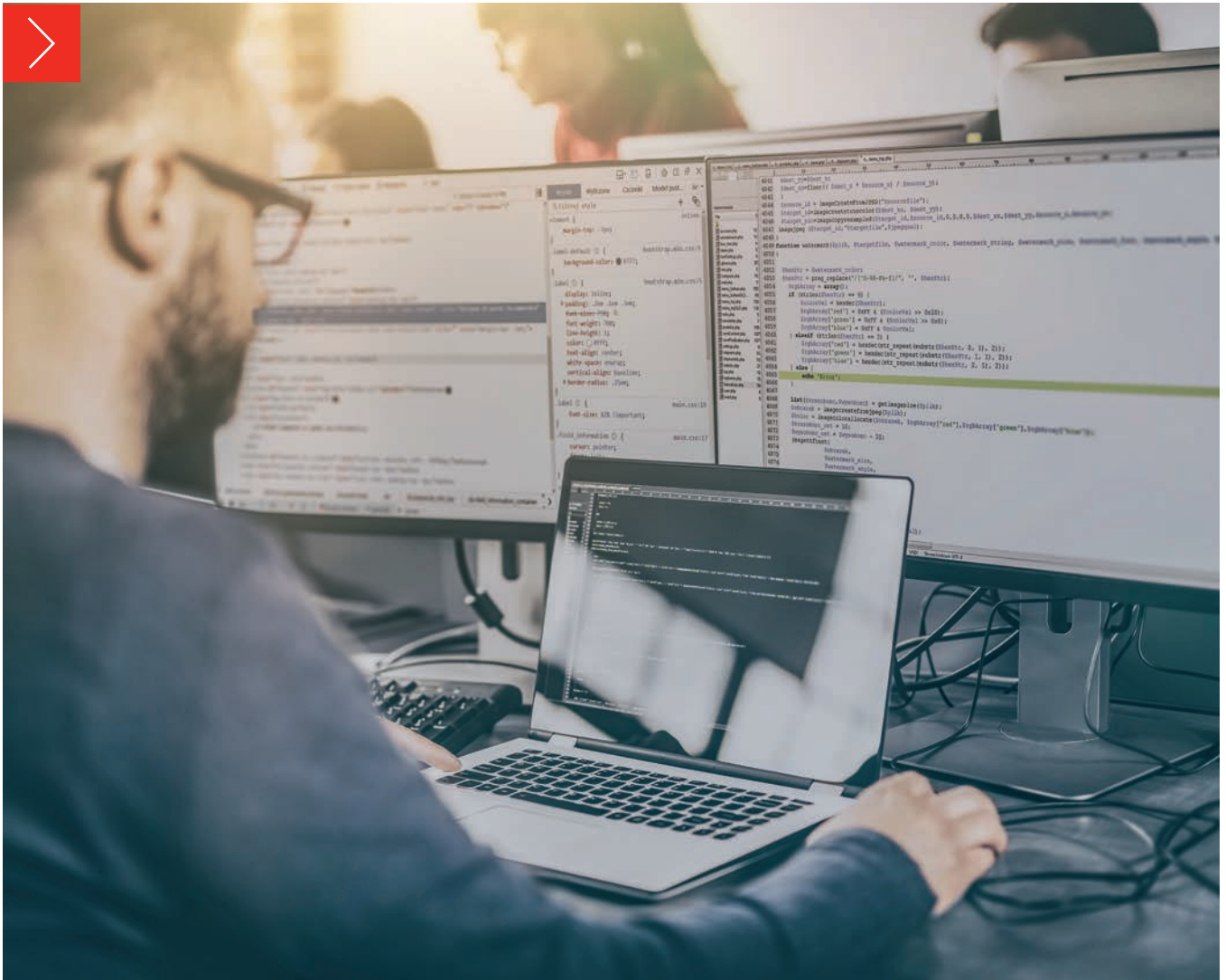

Individual development & special solutions

Along with an extensive hardware and software portfolio, Kathrein Solutions also offers its customers individual developments and special solutions in the field of high-frequency technology. Where “off the rail” solutions reach their limits, the development departments offer a variety of options for implementing customers' digitization and IoT visions.

> R&D services

Readers/Nodes

- HF/UHF RFID readers
- UWB/BLE node
- Concept development
- Customized integration
- Type approvals

Antenna

- UHF, HF antennas
- BLE, UWB antennas
- High gain and multi-polarization antenna
- Application-specific phased arrays
- Development in the range 13 MHz – 8 GHz

Transponders

- HF (NFC) and UHF transponders
- UWB, BLE transponders
- Robust IP67 solutions
- Virtual PoC and application safeguarding with 3D field simulations
- High-security windshield label and headlamp tags

Software/Firmware

- Country profile development
- Customized firmware adaptations
- Application-specific read/write commands
- Real-time localization and direction detection



Passive UHF RFID



Ultra Wide Band RTLS

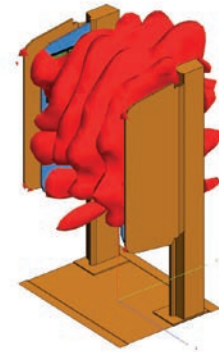

Model Axess AG 2019

> R&D: Order overview

Order number	Name	Description
52010548	R&D hardware	Development of OEM RAIN RFID readers in accordance with customer requirements and specifications
52010549	R&D antenna	Development of OEM RAIN RFID antennas in accordance with customer requirements and specifications
52010550	R&D firmware	Development of specific firmware adaptations in accordance with customer requirements and specifications
52010654	R&D transponder	Development of OEM RAIN RFID special transponders in accordance with customer requirements and specifications

> Cooperation with sparring partners

IDePLATE – the label of tomorrow

The IDePLATE® imprinted aluminum RFID label is equipped with a forgery-proof, theft-proof data chip, making it an outstanding solution for the future. The IDePLATE® guarantees reliable and secure identification of vehicles in stationary and moving traffic, irrespective of traffic volume, weather conditions, vehicle model and speed.



IDeSTIX – Efficient. Modern. Uncomplicated.

IDeSTIX is a high-quality security sticker with integrated RAIN RFID chip, which works according to the same principle as the IDePLATE. In combination with the electronic number plate, the protection against forgery is improved many times over. IDeSTIX® can be used as an alternative to the IDePLATE® RFID license plate, but can also be used in addition to it, which increases the security level even further.



IDeSTIX Headlamp Tag – the electronic label for motorbikes

IDeSTIX is a high-quality security sticker with integrated RAIN RFID chip, which works according to the same principle as the IDePLATE. In combination with the electronic number plate, the protection against forgery is improved many times over. IDeSTIX® can be used as an alternative to the IDePLATE® RFID license plate, but can also be used in addition to it, which increases the security level even further.

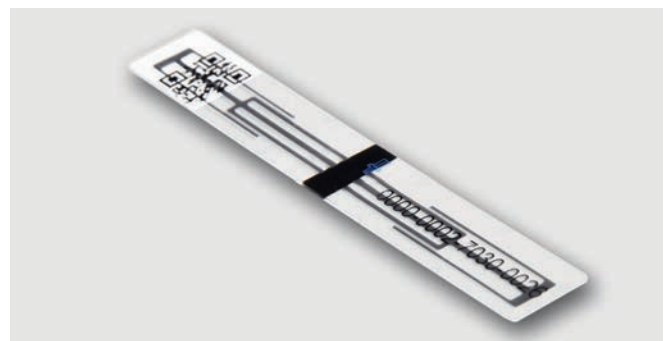

KATHREIN Solutions GmbH
Kronstaudener Weg 1
83071 Stephanskirchen, Germany
Phone +49 8036 90831 0
Fax +49 8036 90831 69
www.kathrein-solutions.com | info@kathrein-solutions.com

KATHREIN